

bradscholars

Analysis of the Effect of EBG on the Mutual Coupling for a two-PIFA Assembly.

Item Type	Conference paper
Authors	Abidin, Z.Z.;Abd-Alhameed, Raed;McEwan, R.A.;Child, Mark B.
Citation	Abidin, Z. Z., Abd-Alhameed, R. A., McEwan, N. J. and Child, M. B. (2010). Analysis of the Effect of EBG on the Mutual Coupling for a two-PIFA Assembly. In: Loughborough Antennas & Propagation Conference (LAPC10), 8-9 November 2010, Loughborough, UK. IEEE. ISBN: 978-1-4244-7306-9/10. pp. 473-476.
Rights	© 2010 IEEE. Reprinted, with permission: Abidin, Z. Z., Abd-Alhameed, R. A., McEwan, N. J. and Child, M. B. (2010). Analysis of the Effect of EBG on the Mutual Coupling for a two-PIFA Assembly. In: Loughborough Antennas & Propagation Conference (LAPC10), 8-9 November 2010, Loughborough, UK. IEEE. ISBN: 978-1-4244-7306-9/10. pp. 473-476. This material is posted here with permission of the IEEE. Such permission of the IEEE does not in any way imply IEEE endorsement of any of the University of Bradford's products or services. Internal or personal use of this material is permitted. However, permission to reprint/republish this material for advertising or promotional purposes or for creating new collective works for resale or redistribution must be obtained from the IEEE by writing to pubs-permissions@ieee.org . By choosing to view this document, you agree to all provisions of the copyright laws protecting it.
Download date	2025-04-26 05:25:27
Link to Item	http://hdl.handle.net/10454/4787

The University of Bradford Institutional Repository

<http://bradscholars.brad.ac.uk>

This work is made available online in accordance with publisher policies. Please refer to the repository record for this item and our Policy Document available from the repository home page for further information.

To see the final version of this work please visit the publisher's website. Where available access to the published online version may require a subscription

Author(s): Abidin, Z. Z., Abd-Alhameed, R. A., McEwan, N. J. and Child, M. B.

Title: Analysis of the Effect of EBG on the Mutual Coupling for a two-PIFA Assembly.

Publication year: 2010

Conference title: Loughborough Antennas & Propagation Conference (LAPC10), 8-9 November 2010, Loughborough, UK.

Publisher: IEEE

Link to original published version:

<http://ieeexplore.ieee.org/stamp/stamp.jsp?tp=&arnumber=5666200>

Citation: Abidin, Z. Z., Abd-Alhameed, R. A., McEwan, N. J. and Child, M. B. (2010). Analysis of the Effect of EBG on the Mutual Coupling for a two-PIFA Assembly. In: Loughborough Antennas & Propagation Conference (LAPC10), 8-9 November 2010, Loughborough, UK. IEEE. ISBN: 978-1-4244-7306-9/10. pp. 473-476.

Copyright statement: © 2010 IEEE. Reprinted, with permission: : Abidin, Z. Z., Abd-Alhameed, R. A., McEwan, N. J. and Child, M. B. (2010). Analysis of the Effect of EBG on the Mutual Coupling for a two-PIFA Assembly. In: Loughborough Antennas & Propagation Conference (LAPC10), 8-9 November 2010, Loughborough, UK. IEEE. ISBN: 978-1-4244-7306-9/10. pp. 473-476.

This material is posted here with permission of the IEEE. Such permission of the IEEE does not in any way imply IEEE endorsement of any of the University of Bradford's products or services. Internal or personal use of this material is permitted. However, permission to reprint/republish this material for advertising or promotional purposes or for creating new collective works for resale or redistribution must be obtained from the IEEE by writing to pubs-

permissions@ieee.org. By choosing to view this document, you agree to all provisions of the copyright laws protecting it.

Analysis of the Effect of EBG on the Mutual Coupling for a two-PIFA Assembly.

Z. Z. Abidin^{#1*}, R.A. Abd-Alhameed^{#2}, N.J. McEwan^{#3} and M.B. Child^{#4}

[#] *Mobile & Satellite Communications Research Centre, School of Engineering, University of Bradford, Bradford, West Yorkshire, United Kingdom, BD7 1DP*

¹z.b.zainalabidin@bradford.ac.uk, ²r.a.a.abd@bradford.ac.uk

³n.j.mcewan@bradford.ac.uk, ⁴m.b.child@bradford.ac.uk

^{*} *Faculty of Electrical and Electronic Engineering, Universiti Tun Hussein Onn Malaysia, Parit Raja, Batu Pahat, Malaysia.*

Abstract— Size constraints and mutual coupling on the performance of a two-element PIFA assembly are investigated for a design frequency of 2.4 GHz. A benchmark antenna assembly, employing a normal metallic ground plane is compared with an EBG modified ground plane. The height of the antenna elements over the EBG is optimised, and an isolation factor of 9.12 dB is achieved for a gap of 2.5 mm. Prototype structures have been constructed and measured for both cases.

I. INTRODUCTION

This paper investigates the mutual coupling experienced in a two-element antenna array operating at 2.4 GHz, the antenna elements are planar inverted F structures (PIFA), and the investigation takes into account the possibility of replacing a conventional metal ground plane with a modified EBG structure [1]. The size and performance requirements found in many mobile user terminals, handsets, and vehicular applications lead naturally to the use of printed dipoles, and similar structures, operated against a metallic ground. In addition to this background it is also necessary to consider the current evolution towards realistic MIMO user terminals. Eventually miniaturised multi-antenna modules are expected to become routine requirements. PIFA structures have been selected for this study because of their electrical performance, and compact design features. However, there are several physical constraints which apply in attempting miniaturisation of such antennas, particularly with respect to reductions in substrate thickness. If this process is applied, the gross size reductions are achieved at the cost of poor radiation performance, and mutual coupling, between the elements, and with the user. Several attempts have been made to mitigate this situation through the selective application of metamaterials [2-5]. Conventional PIFA designs are reviewed in [6-10]. A design making use of metamaterial loaded walls, using a Sievenpiper (i.e. ‘mushroom’) structure is given in [11].

II. CONVENTIONAL 2-PIFA ASSEMBLY.

The basic geometrical configuration of the PIFA assembly is shown in Fig. 1. The design frequency in this study is 2.4 GHz, the antenna assembly is mounted on a $0.8\lambda \times 0.4\lambda$ ($L_g \times W_g$) ground plane. The antennas are constructed from a 0.5mm thick plate, with a maximum area of $0.24\lambda \times 0.088\lambda$ ($l_p \times w_p$) and from the edge of the ground plane of

0.252λ (g). The surface of the patch has a $0.048\lambda \times 0.056\lambda$ ($l_s \times w_s$) slot cut away. A shorting plate of height 6.5mm (h) is also present. The antenna is fed with a 5Ω coaxial line, with a gap of 0.1λ (x) from the edge. The inter-element spacing of the two-antenna assembly is 0.128λ (d). The substrate has a relative permittivity of 4.5, and loss tangent of 0.002 at 2.4 GHz, the substrate thickness is 1.6mm (t). The structure was modelled in the time domain using CST Microwave Studio, and the optimised structure parameters were used to construct a working prototype. The predicted and measured scattering parameters are shown in Fig. 2. The predictions for return loss and mutual coupling are quite accurate, and the measured impedance bandwidth is 6.4% from 2.37 GHz to 2.53 GHz, with a maximum coupling level of -13.26 dB at 2.4 GHz. The apparent drift from prediction in the measured results is believed to be due to minor inconsistencies in the prototyping.

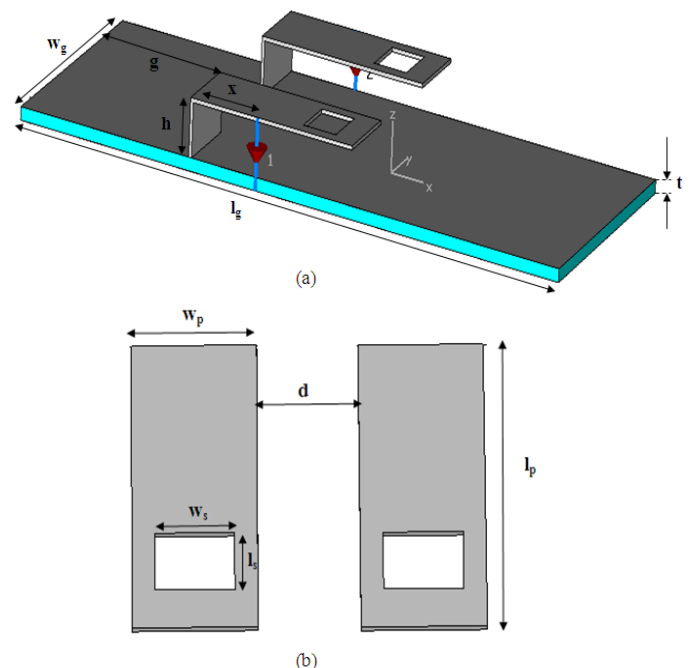

Fig. 1: Geometries of the 2-PIFA benchmark assembly: (a) 3-D schematic and (b) PIFAs geometries.

III. PIFA WITH EBG STRUCTURE.

Having established a conventional benchmark, an EBG modified ground plane [1] is implemented, and is shown in Fig. 3. The EBG unit cell is shown in detail in Fig. 4, with the dimensions of: 9.7 mm (a), 0.2mm (b), 4.0 mm (c), 0.2mm (g), and 0.2mm (w). To obtain the target performance, the EBG has been realised from the 3×9 periodic lattice. The suspended microstrip process is applied to measure the bandgap characteristics of the structure [12]. Fig. 5 shows the transmission coefficient of the structure [12]. Fig. 5 shows the transmission coefficient of the structure [12]. Fig. 5 shows the transmission coefficient of the structure [12].

The scattering parameter landscape is compared for both the benchmark and EBG modified structures (Fig. 6). It can be seen that the resonant frequency of the modified structure has been shifted down to 2.38 GHz, with an effective operating range of 2.35 GHz to 2.45 GHz. The maximum return loss at 2.4 GHz is -11.11 dB. In the benchmark structure, there is a strong mutual coupling of -13.26 dB; whereas in the EBG modified structure an isolation of 5.12 dB is recorded at 2.4 GHz. Fig. 6, indicates that the EBG can reduce the mutual coupling between the PIFAs. The effect of decreasing the air gap between the PIFA structures and the EBG was studied parametrically, and the variations in isolation, gain, and antenna efficiency analysed.

IV. PARAMETRIC STUDIES.

The primary goal of the parameter studies was to form a semi-empirical understanding of the mutual coupling between the PIFAs. Two outcomes are expected: firstly, to reduce the mutual coupling effect between two PIFAs, and secondly to enhance the antenna efficiency. The height of the PIFA in the EBG modified case is gradually reduced from 6.5 mm to 2.5 mm, while the other structure parameters of the PIFAs and EBG are held constant. This reduction in height between the two PIFAs and the EBG apparently mitigates the effects of mutual coupling, and thus improves the antenna efficiency. Table 1 provides a summary of antenna performance vs. height of the PIFAs above the EBG. The optimal height for this assembly appears to be 2.5 mm and a physical prototype was constructed on this basis.

The reflection and transmission properties of this prototype were measured on a HP8510C VNA. The predicted and measured results of EBG modified structure are plotted in Fig. 7. The EBG displays asymmetry in S_{11} and S_{22} . The relative impedance bandwidth is approximately 3.53% over the range 2.38 GHz to 2.47 GHz, for $|S_{11}| < -10$ dB at both ports (Fig. 7 (a)). Meanwhile, Fig. 7 (b) indicates a maximum mutual coupling of -22.42 dB for both measured and predicted results. Fig. 8 shows the mutual coupling between the benchmark structure and EBG modified structure. It can be seen that an isolation of 9.12 dB is achievable against the benchmark structure. The total efficiency of both structures is given in Fig. 9 and it shows an increase of 2.81% for the EBG modified structure at 2.4 GHz.

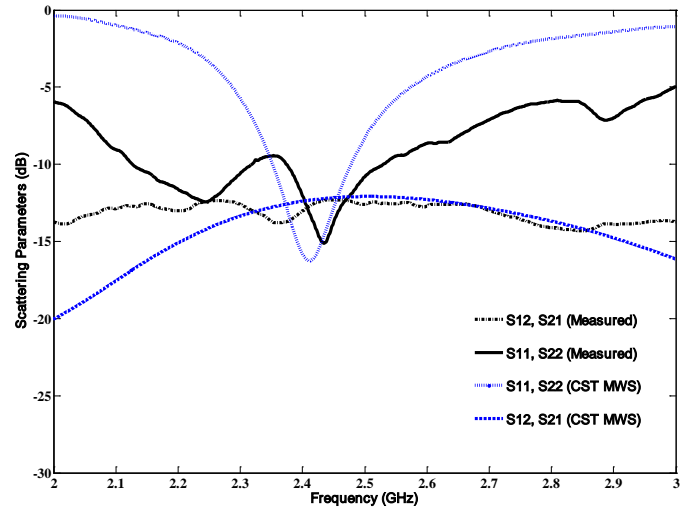

Fig. 2: Comparative plot of s-parameter output for simulated and measured results, using the benchmark assembly

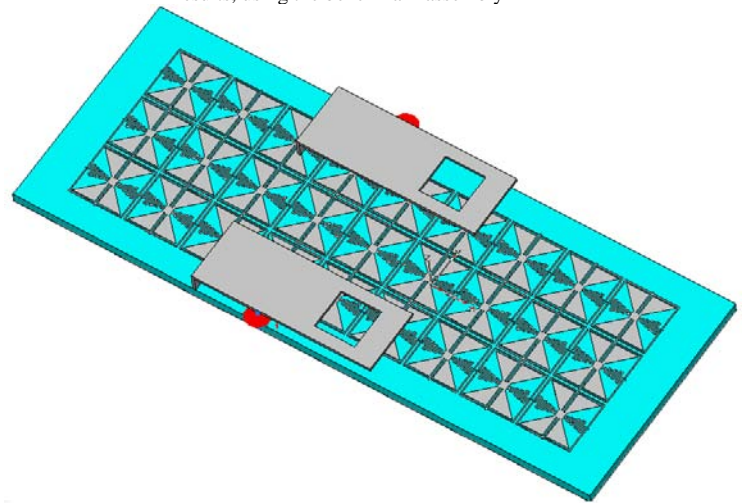

Fig 3: 3D schematic of EBG-modified 2-PIFA assembly.

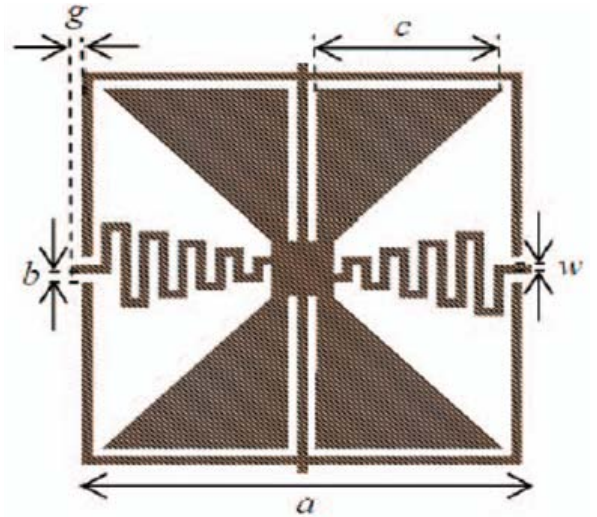

Fig. 4: Layout of unit cell for the adopted EBG structure.

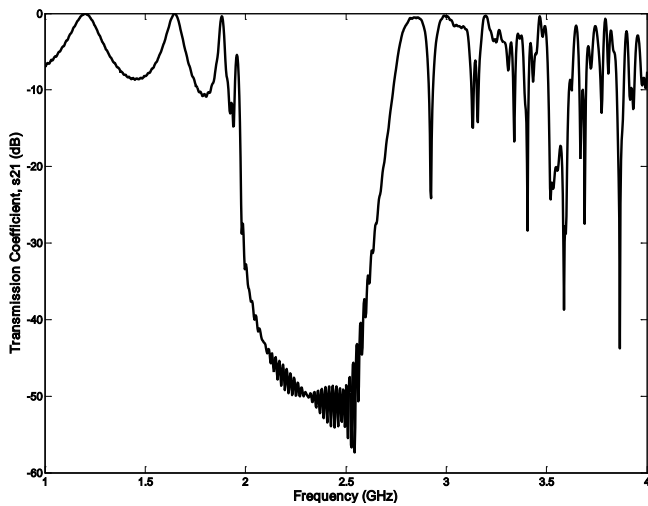

Fig. 5: S_{21} parameter of the EBG structure.

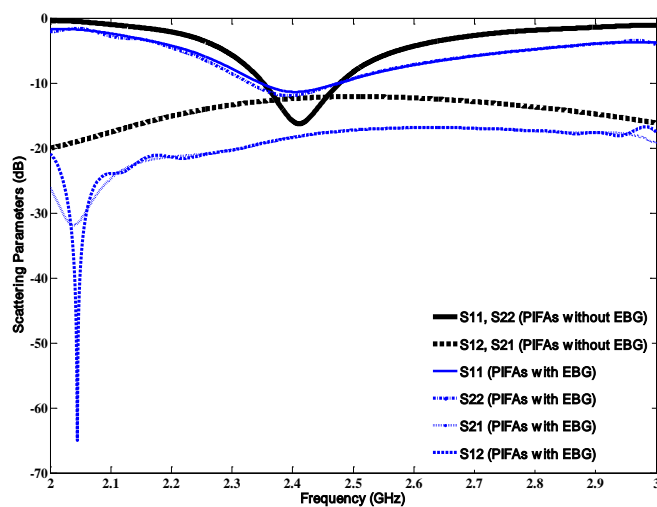

Fig. 6: Simulated scattering parameters for the benchmark and EBG-modified assemblies.

CONCLUSIONS.

The mutual coupling effect between a two-element PIFA array, with and without EBG, operating at a design frequency of 2.4 GHz has been presented. The predicted and measured results are in reasonably close agreement. Measurements on the prototype indicated a 9.12 dB improvement in isolation with an air gap height of 4mm for the EBG modified assembly. The antenna efficiency of the EBG PIFA assembly is slightly improved as compared with the benchmark structure. The structure is essentially simple, and uses a well established antenna design, thus making an attractive possible candidate for a MIMO handset antenna module; also more widely, the basic result might be further developed for MIMO array designs, with a different choice of radiator.

ACKNOWLEDGMENT

Z.Z. Abidin would like to thank Mr. K.N.B.Ramli and Mr. A. G. Alhaddad for help in the practical assembly and testing,

and the University Tun Hussein Onn Malaysia for her financial support.

REFERENCES

- [1] Z. Z. Abidin, R.A.Abd-Alhameed, N. J. McEwan, S. M. R. Jones, K. N. Ramli, and A. G. Alhaddad, "Design and Analysis of UC-EBG on Mutual Coupling Reduction," *Loughborough Antennas & Propagation Conference* pp. 693-696, 2009.
- [2] D. Sievenpiper, "High-Impedance Electromagnetic Surfaces," *Ph.D. Dissertation, Department of Electrical Engineering, University of California, Los Angeles*, 1999.
- [3] Y. Zhao, Y. Hao, and C. G. Parini, "Radiation properties of PIFA on electromagnetic bandgap substrates," *Microwave and Optical Technology Letters*, vol. 44, pp. 21-24, 2005.
- [4] Q. Luo, H. M. Salgado, and J. R. Pereira, "EBG PIFA design for WLAN applications," *IEEE Antennas and Propagation Society International Symposium*, pp. 1-4, 2008.
- [5] Z. Du, K. Gong, J. S. Fu, B. Gao, and Z. Feng, "A compact planar inverted-F antenna with a PBG-type ground plane for mobile communications," *IEEE Transactions on Vehicular Technology*, vol. 52, pp. 483-489, 2003.
- [6] J.-H. Choi, Y.-S. Shin, and S.-O. Park, "Performance evaluation of 2 x 2 MIMO handset antenna arrays for mobile WiMAX applications," *Microwave and Optical Technology Letters*, vol. 51, pp. 15581561, 2009.
- [7] A. Diallo, C. Luxey, P. Le Thuc, R. Staraj, and G. Kossiavass, "Reduction of the mutual coupling between two planar inverted - F antennas working in close radio communication standards," *18th International Conference on Applied Electromagnetics and Communications*, pp. 1-4, 2005.
- [8] A. Diallo, C. Luxey, P. Le Thuc, R. Staraj, and G. Kossiavass, "Study and Reduction of the Mutual Coupling Between Two Mobile Phone PIFAs Operating in the DCS1800 and UMTS Bands," *IEEE Transactions on Antennas and Propagation*, vol. 54, pp. 3063-3070, 2006.
- [9] M. Karaboikis, C. Soras, G. Tsachtsiris, and V. Makios, "Compact dual-printed inverted-F antenna diversity systems for portable wireless devices," *IEEE Antennas and Wireless Propagation Letters*, vol. 3, pp. 9 - 14 2004.
- [10] J. Thaysen and K. B. Jakobsen, "Design considerations for low antenna correlation and mutual coupling reduction in multi antenna terminals," *European Transaction on Telecommunications*, vol. 18, pp. 319-326, 2007.
- [11] F. Jolani, A. M. Dadgarpour, and G. Dadashzadeh, "Reduction of Mutual Coupling between Dual - Element Antennas with New PBG Techniques," *13th International Symposium on Antenna Technology and Applied Electromagnetics and the Canadian Radio Sciences Meeting*, pp. 1-4, 2009.
- [12] M. Y. Fan, R. Hu, Z. H. Feng, X. X. Zhang, and Q. Hao, "Advance in 2D-EBG research," *J. Infrared Millim. Waves*, vol. 22, 2003.

TABLE 1

SUMMARY OF RETURN LOSS, MUTUAL COUPLING, ANTENNA GAIN AND ANTENNA EFFICIENCY FOR DIFFERENT HEIGHT OF PIFA FROM EBG SURFACE

PIFA height from EBG (mm)	Return Loss, (dB)		Mutual Coupling, (dB)		Antenna gain (dBi)	Antenna Efficiency (%)
	S_{11}	S_{22}	S_{12}	S_{21}		
6.50	-10.596	-11.11	-18.38	-18.37	2.993	89.79
5.50	-12.01	-11.71	-19.24	-19.31	2.916	92.45
4.50	-11.05	-11.48	-20.42	-20.59	2.910	90.90
3.50	-14.04	-17.23	-20.71	-20.71	3.037	93.90
2.50	-17.16	-18.84	-22.43	-22.33	3.471	97.59

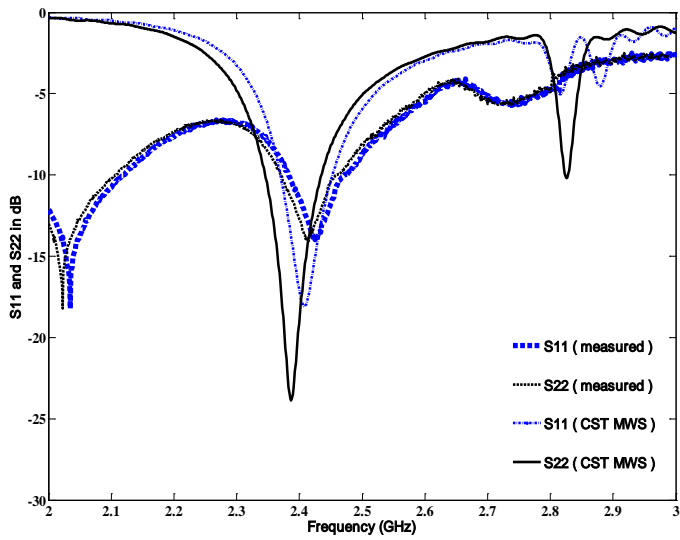

(a)

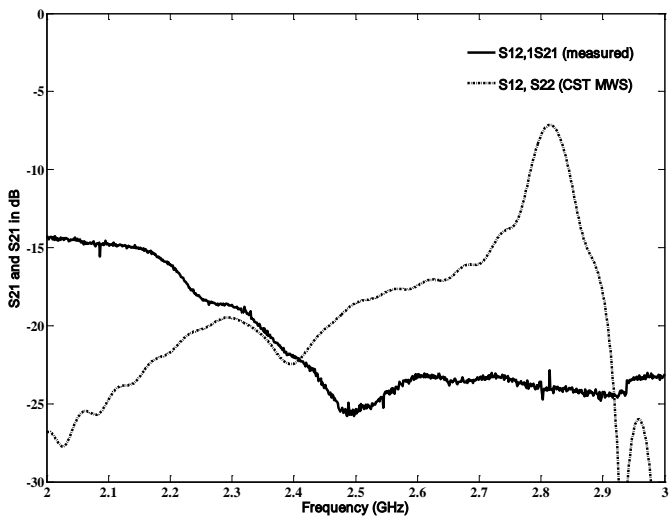

(b)

Fig. 7: Comparison of simulated and measured scattering parameters of PIFAs EBG: (a) reflection, (b) transmission.

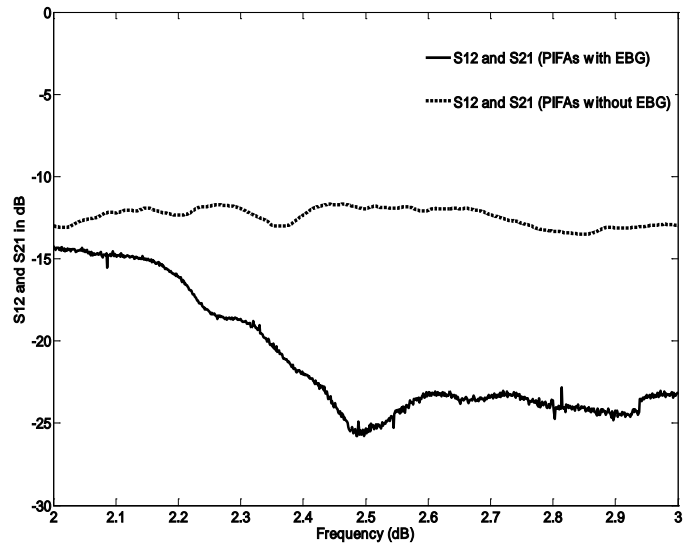

Fig. 8: Measured isolation of PIFAs with and without EBG.

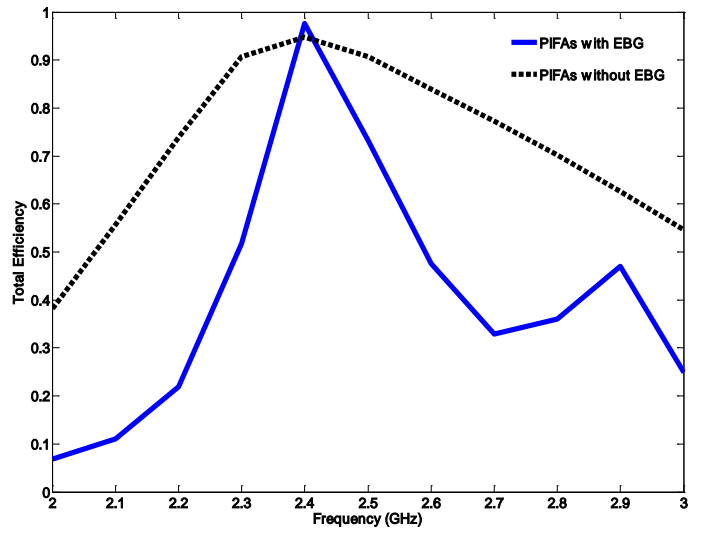

Fig. 9: Comparison of simulated total efficiency, for benchmark and EBG-modified assemblies.