

bradscholars

FEM and CFD Co-simulation Study of a Ventilated Disc Brake Heat Transfer

Item Type	Conference paper
Authors	Tang, Jinghan;Qi, Hong Sheng
Citation	Tang J and Qi HS (2013) FEM and CFD Co-simulation Study of a Ventilated Disc Brake Heat Transfer. EuroBrake 2013, Dresden Germany, 17-19 June 2013. In: EuroBrake 2013 Conference Proceedings. FISITA. ISBN: 978-0-9572076-0-8.
Rights	© 2013 FISITA. Reproduced with the permission of the publisher and in accordance with the publisher's self-archiving policy.
Download date	2026-05-08 09:02:59
Link to Item	http://hdl.handle.net/10454/7973



The University of Bradford Institutional Repository

<http://bradscholars.brad.ac.uk>

This work is made available online in accordance with publisher policies. Please refer to the repository record for this item and our Policy Document available from the repository home page for further information.

To see the final version of this work please visit the publisher's website. Available access to the published online version may require a subscription.

Link to original published version: <http://www.fisita.com/publications/bookstore?id=474>

Citation: Tang J and Qi HS (2013) FEM and CFD Co-simulation Study of a Ventilated Disc Brake Heat Transfer. EuroBrake 2013, Dresden Germany, 17-19 June 2013. In: EuroBrake 2013 Conference Proceedings. FISITA. ISBN: 978-0-9572076-0-8.

Copyright statement: © 2013 FISITA. Reproduced with the permission of the publisher and in accordance with the publisher's self-archiving policy.

FEM AND CFD CO-SIMULATION STUDY OF A VENTILATED DISC BRAKE HEAT TRANSFER

¹Jinghan, Tang, ¹Hongsheng, Qi*

¹University of Bradford, United Kingdom

KEYWORDS – FEM, CFD, Co-simulation, disc brake cooling, heat transfer coefficient

ABSTRACT – This paper presents a two-way thermally-coupled FEM-CFD co-simulation method for ventilated brake disc rotor heat transfer analysis. Using a third party coupling interface for data mapping and exchange, the FEM and CFD models run simultaneously under a standard heavy duty braking test condition. By comparison with conventional one-way coupling methods and experimental results, the performance of the co-simulation system has been investigated in terms of prediction of the heat transfer coefficient (HTC) and disc temperatures as well as computing time used. The results illustrate that this co-simulation method has good capacity in providing cooling effect and temperature predictions. It also shows that the data exchange between the FEM and CFD codes at every time increment is highly accurate and efficient throughout 10 brake applications. It can be seen that the co-simulation method is more time efficient, convenient and robust compared to previous one-way coupling methods. To utilize the potential of this method, future works are proposed.

1 INTRODUCTION

With the increasing requirement of vehicle thermal safety (e.g. preventing thermal fade), the braking system cooling performance and effective design of ventilated disc rotors becomes very significant. In traditional finite element method (FEM) thermal simulation, the disc surface Heat Transfer Coefficient (HTC) is normally obtained using empirical equations (1). However, the empirical equations have limitations in predicting the accurate HTC distribution and magnitude on all surfaces of a ventilated disc in a dynamic braking process. To overcome this problem, an increasing number of researches in recent years used computational fluid dynamic (CFD) techniques in the cooling analysis of brake systems. Therefore, in order to enable the cooling data transfer from CFD to FEM codes, the FEM-CFD coupling approach has becoming an important emerging technical option (2). In the research area of disc brake thermal analysis, several coupling approaches have been performed recently. In 2010, Pevac, et al. predicted the temperature evolution of a ventilated disc under a repetitive brake test condition using a numerical approach combining CFD steady-state HTC distribution analysis and FEM temperature analysis (3). In this analysis, initially the steady-state HTC distribution for a brake disc, under different disc rotating speed and temperature, was obtained using CFD analysis, and subsequently the HTC results were presented in the form of property table in the input file of FEM model for the disc temperature prediction. The work showed good agreement between the simulation results from the steady-state HTC obtaining approach and the results from experiments. Similarly, Belhocine and Bouchetara determined the HTC on each surface of a ventilated disc rotor varying with time in a transient state using CFD analysis, and then imported the surface film condition data into a corresponding FEM model for disc temperature analysis (4). Results showed that the transient-coupling method corresponded well with their previous experimental work. The main limitations of the aforementioned CFD-FEM methods are:

- These approaches involves some inevitable time consuming manual work, such as cooling data collection and arrangement for the velocity and temperature depended HTC property table in FEM or importing film conditions into FEM input files etc.
- The time depended HTC distribution data are simplified in some of the semi-automatic or manual data transfer or data mapping approach which can bring inaccuracy in temperature prediction results.
- As these approaches are one-way coupling method which only enabled the cooling data transfer from CFD into the FEM models, whereas the other factors of the convective heat flux boundary conditions (e.g. disc surface temperature) are predefined as constants.

In order to improve the temperature predication accuracy and time efficiency when using combined FEM and CFD method in disc brake thermal analysis, this paper presents a transient two-way thermally-coupled FEM-CFD co-simulation system for the analysis of a ventilated disc brake under a heavy duty brake test condition.

2 CASE USED FOR THE STUDY

To investigate the advantages and disadvantages of the proposed two-way thermally-coupled co-simulation method, the disc geometry (41 cooling vanes), material (grey cast irons EN-GJL-250, see Table 1) and braking applications used in this research are the same with that used by Pevec et al. (3) in their one-way CFD-FEM coupling research. The assembly and geometry of the ventilated braking system is shown in Figure 1.

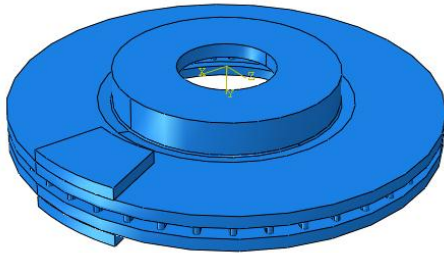

Figure 1: Disc and pad assembly

Table 1: Material data for the cast iron disc, EN-GJL-250 (5)

Temperature	100 °C	200 °C	300 °C	400 °C	500 °C
Thermal conductivity (W/mK)	48.5	47.5	46.5	45	44.5
Specific heat C_p (J/kgK)	537				
Density ρ (kg/m ³)	7200				
Elastic module E (MPa)	100213				
Poisson number ν	0.26				

Table 2: Vehicle data and braking data for the co-simulation (3)

Nomenclature and units	Value
Vehicle mass $-m_{vehicle}$ (Kg)	1760
Initial speed $-v_{init}$ (km/h)	100
Acceleration $-a_c$ (m/s ²)	1.73
Deceleration $-a$ (m/s ²)	9.8
Brake distribution for front $-d_{f/r}$ (%)	76
Outer friction radius of pad $-r_o$ (mm)	139
Inner friction radius of pad $-r_i$ (mm)	93.5
Share of absorbed heat by disc $-\eta_{disc}$ (%)	99

The selected braking operation is the Auto-Motor-Sport (AMS) brake performance test standard, which consists of 10 brake cycles in 187 seconds, with each of the cycles consisting of a 2.8 seconds deceleration phase and followed by a 15.9 seconds acceleration phase (3). Figure 2 shows the vehicle velocity time course. It is assumed that the initial disc temperature is uniformly 100 °C and the ambient air temperature was 30 °C during the braking operation. The other vehicle data and braking data are listed in Table 2.

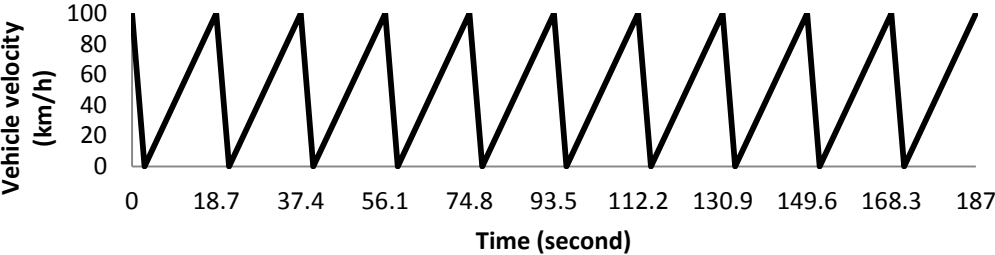

Figure 2: vehicle velocity time courses

3 NUMERICAL MODELING OF CO-SIMULATION

3.1 Co-simulation environment

To achieve high accuracy, fully automated and efficient FEM-CFD data exchange in the two-way thermally-coupled FEM-CFD heat transfer co-simulation, a third party coupling interface software MpCCI was used which developed by Fraunhofer SCAI specifically for multi-physics data exchange between codes (2). Figure 3 shows this two-way thermal coupled FEM-CFD heat transfer co-simulation environment and the basic data exchange process in one time step. The FEM software ‘ABAQUS’ was used to model the solid heat conduction in the disc. The CFD code ‘FLUENT’ was used to estimate the convective cooling in a transient state. All these three packages were launched and running simultaneously after finishing the setups of FEM and CFD models. In each time step, the disc temperature, film temperature and HTCs were calculated and then the corresponding surface data were exchanged automatically before moving to next time step. Both the FEM and CFD codes had identical fixed time increment size ($\Delta t = 0.1s$) and identical geometries in the coupling regions whereas the meshes could be non-coincident. The co-simulation completely runs throughout the continuous 10 brake applications with 1870 time steps. The total computing time was 92min for totally 44258 elements (40406 in CFD, 3852 in FEM), using a standard PC.

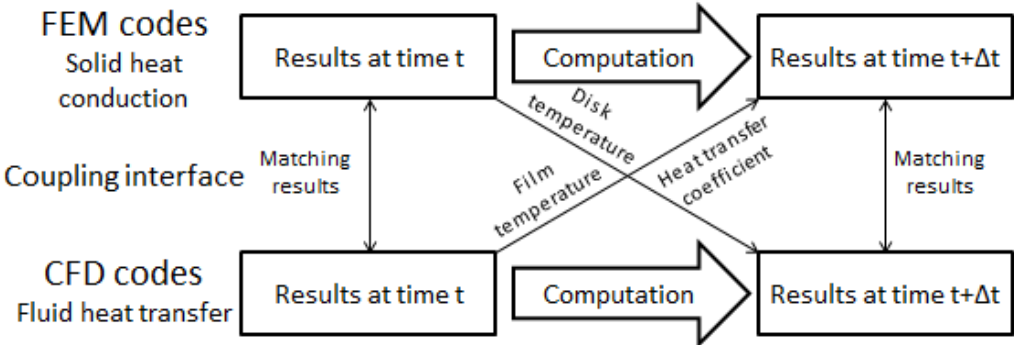

Figure 3: The two way coupling data exchange time course (adapted from (2))

3.2 CFD model

In order to deal with the complexity and high resource demanding when using the co-simulation approach, the flow field was simplified to a periodic repetitive symmetric model, as shown in Figure 4. The disc model is a 26.34 °segment with three channels was set up, which has the same geometry with the disc model in (3). The flow field boundary conditions setup was adopted from (3, 4 and 6). RNG k-ε (k-epsilon) viscosity model was chosen to describe the disc rotation. The surface roughness height was taken at 0.01mm (3).

To describe the transient rotation velocity variation of disc under the AMS test condition, the user defined function (UDF) codes were created and compiled. By using the UDF, the time depended tangential velocity of the disc and coordinate can be calculated and then be arranged as the momentum boundary conditions in the CFD simulation (7, 8).

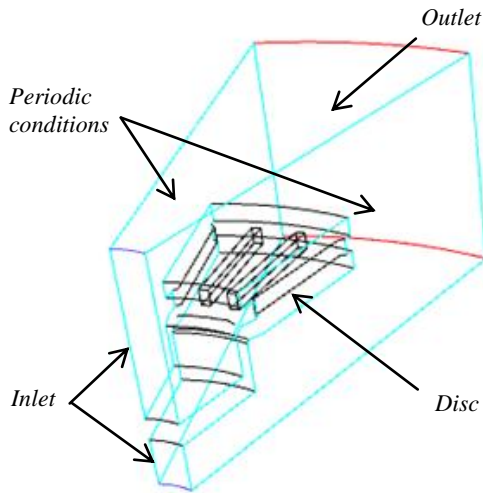

Figure 4: CFD model flow field geometry and boundary conditions

3.3 FEM model

As the requirement of data mapping, the FEM model for the disc had the same geometry in the co-simulation region (as shown in Figure 7 and 11) as the CFD model. As a cyclic symmetric model was assumed, the heat flux applied uniformly on the surfaces shown in Figure 5. This disc brake heat flux load simplification has been widely used in this kind of thermal analysis (3), (4) and (9).

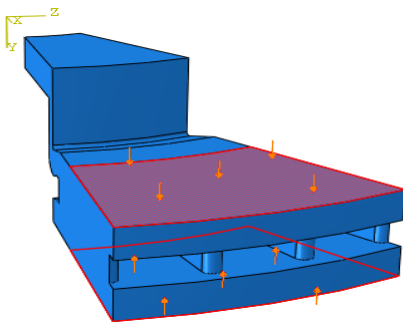

Figure 5: FEM model and heat flux input

The heat flux was calculated using Equation 1 which was adapted from (3):

$$q(t) = \frac{(1-t/t_{stop}) * m_{vehicle} * |a| * d_f / r * v_{init} * \eta_{disc}}{4 * \pi * (r_o^2 - r_i^2)} \quad (1)$$

where $q(t)$ is the heat flux and t_{stop} is the vehicle stopping time. The other notations in Equation 1 and data used are provided in Tables 1 and 2. Figure 6 shows the calculation result for the heat flux load input as a function of time throughout the 10 brake applications under the AMS test condition. It can be seen that the maximum heat flux was 2700 kW/m^2 occurred at the beginning of each brake application and subsequently decreased to zero at the end of each brake application. The heat flux remained zero during the vehicle acceleration period.

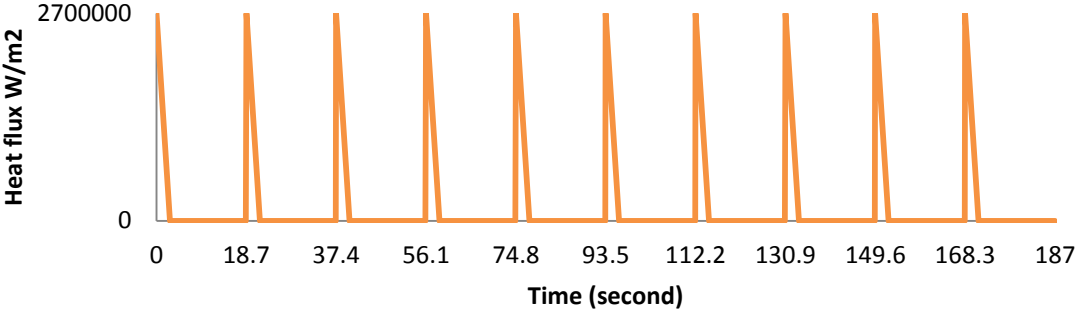

Figure 6: Heat flux input time course

4 RESULTS

4.1 Flow field results

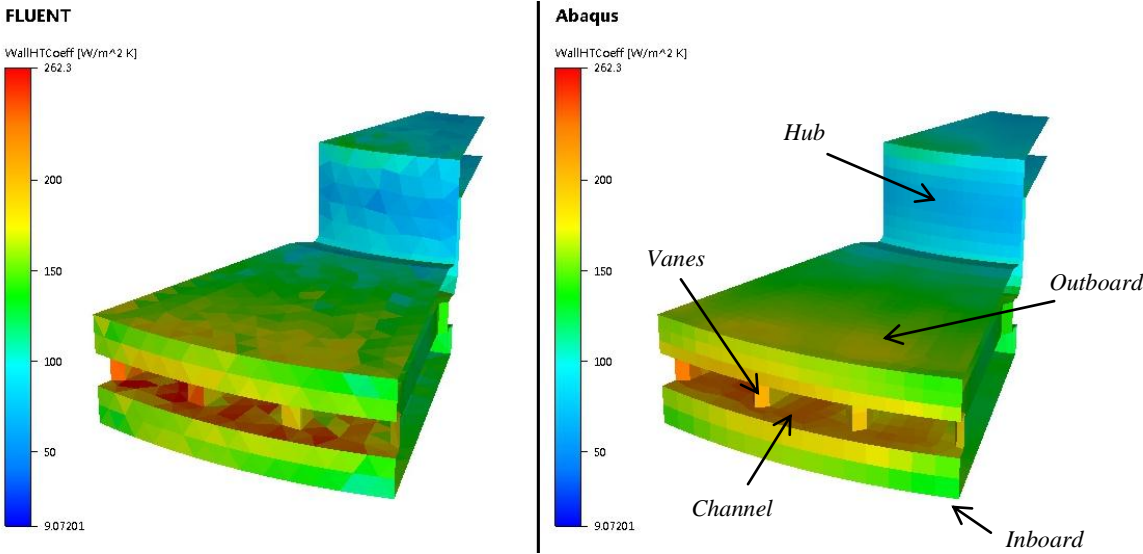

Figure 7: Wall function HTC distribution at 100 km/h

Figure 7 shows the CFD and FEM HTC distributions respectively at the coupling surface regions of the disc at 100 km/h in MpCCI visualizer. It can be seen that a high level of matching has been achieved between the two models with different meshes in terms of the HTC distributions. This indicated that the calculation results of HTC from CFD were properly applied onto the corresponding FEM model surfaces by MpCCI. The maximum HTC appeared in the outer channel area reaching $262 \text{ W/m}^2\text{K}$, as shown in Figure 7. The HTC increased along the radial direction, which indicated the correlation between the HTC and the tangential linear velocity.

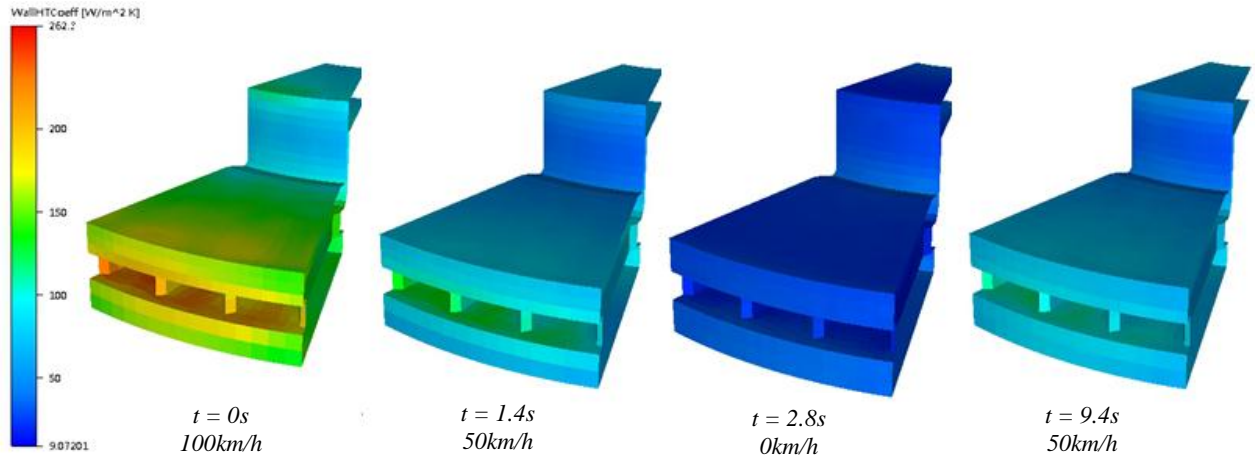

Figure 8: Transient wall function HTC distribution varying with time displayed in ABAQUS

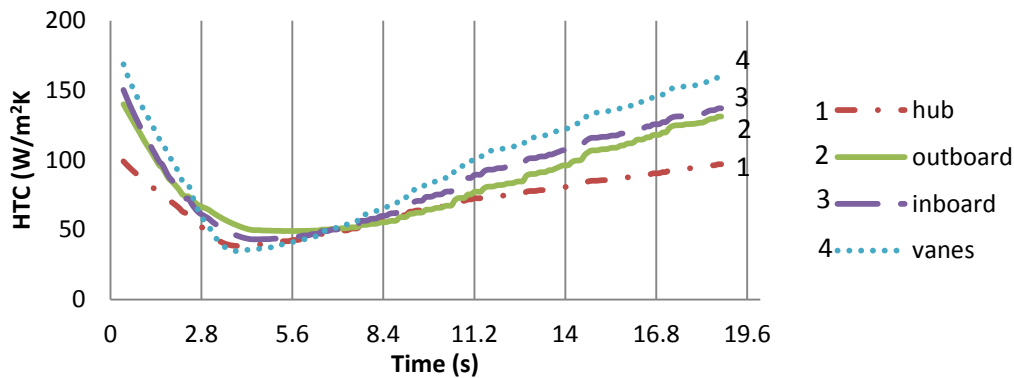

Figure 9: Transient area-weighted average HTC at different disc surfaces vs. time for the first brake application

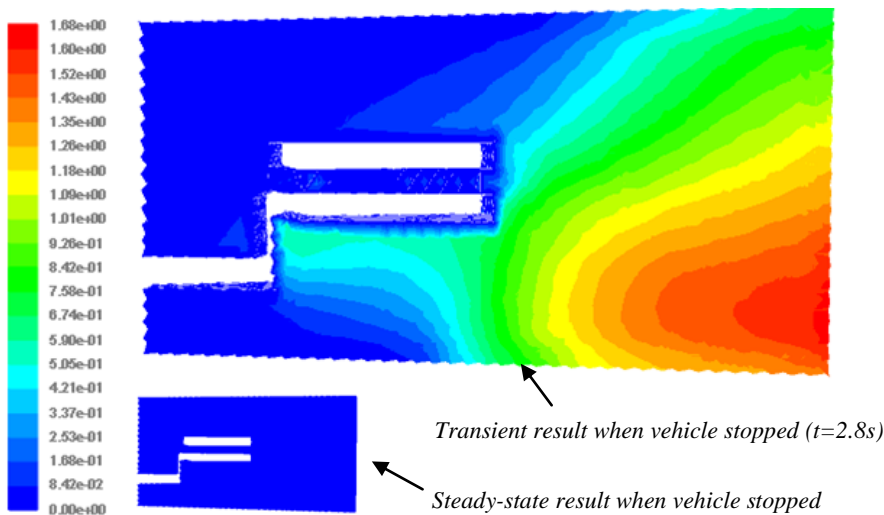

Figure 10: Comparison of ambient air velocity contours (m/s) between a transient-state and a steady-state at the moment when vehicle just reached to zero.

Figure 8 shows the HTC distributions at the time instants of 0s (100 km/h, maximum velocity), 1.4s (50 km/h, middle way of braking), 2.8s (0 km/h, minimum velocity) and 9.4s (50 km/h, middle way of acceleration). It revealed a transient characteristic of the HTC, which varied as function of the vehicle velocity. Furthermore, in comparing the distribution at time 1.4s and 9.4s, it is found that even at same velocity, i.e. 50 km/h, the HTC distribution in

acceleration and deceleration phases are not same. This phenomenon cannot be observed or captured under a steady-state CFD analysis.

Figure 9 is the comparison of the surface average HTC's at different surfaces of the disc during the first brake application. It shows that the vanes have the highest cooling effect with largest HTC variation during individual brake application, whereas the hub has the lowest cooling effect and lest variation. In addition, it was noticed that the lowest HTC value occurred at $t \approx 4s$ instead of at 2.8s (vehicle velocity = 0 km/h). The transient-state CFD simulation shows that the ambient air still had some residual velocity (approximately 0.1-0.5m/s on disc surface) even the rotation speed of the disc reached to zero at 2.8s as shown in Figure 10. Again it can be seen that such phenomenon cannot be appreciated in a steady-state CFD simulation.

4.2 Temperature field results

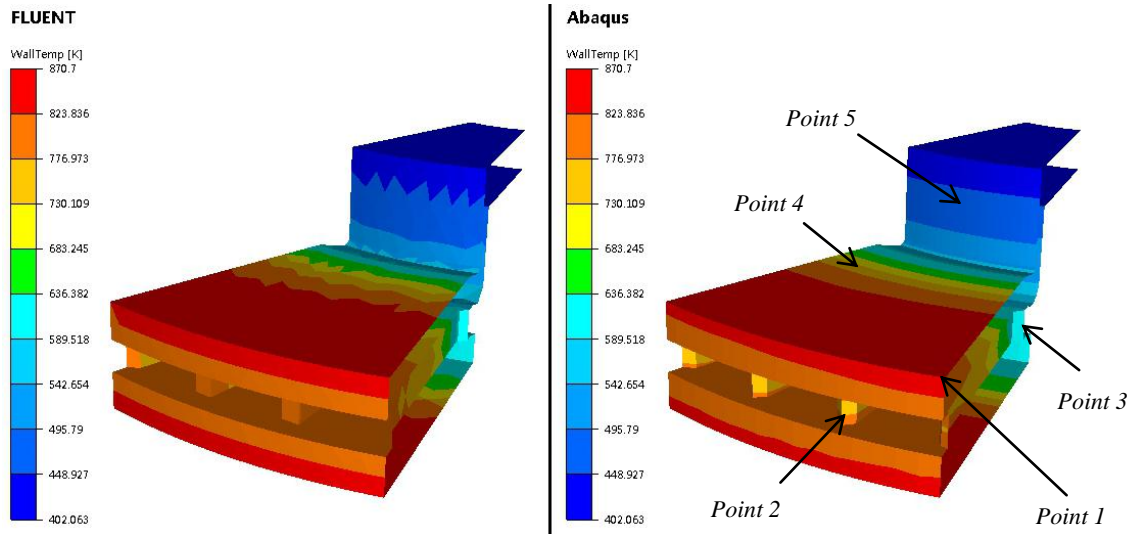

Figure 11: Disc surface temperature distributions at 171s and the picked points to be plotted in Figure 12

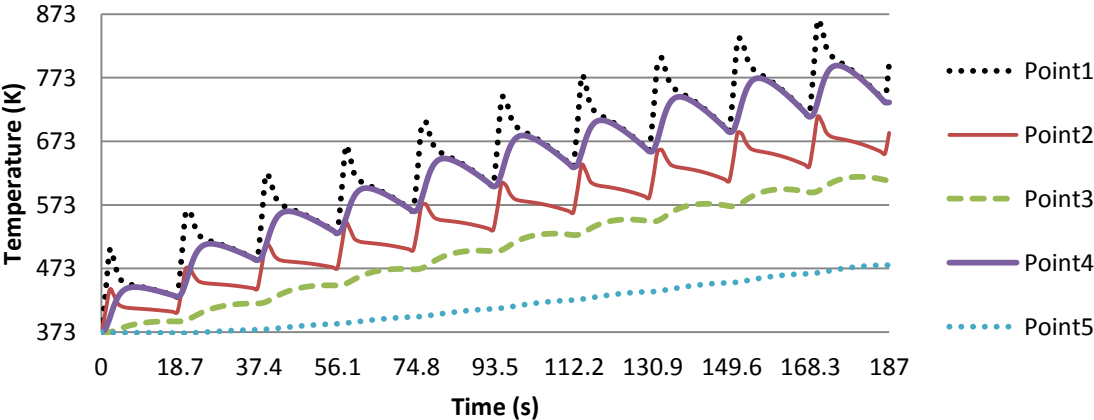

Figure 12: Temperature evolution plots of the picked points in Figure 11

Figure 11 shows the temperature distributions at the coupling surface regions of the disc in FLUENT and ABAQUS respectively using MpCCI visualizer, at $t = 171s$ after 10 brake applications when the disc reached maximum temperature under the AMS test condition. It can be seen that a high level of matching between the two models was achieved, in terms of the surface temperature distributions. This indicates that the calculation results of the surface

temperatures from FEM were properly applied onto the corresponding CFD model surfaces using the MpCCI codes. In addition, it shows that the highest temperature occurred at the inboard and outboard surfaces, reached 870.7K at $t = 171s$ and the disc temperature increased along the disc radial direction.

Figure 12 plots the temperature evolution curves for different points on the disc model indicated in Figure 11. For point 1, the temperature reached the maximum value of 870.7 K at 171s in the 10th braking application. Comparing the temperature evolution at earlier brake applications with later brake applications, it reveals that the temperature drop during the acceleration (or cooling) phase for each brake application increased with the growth of disc temperature (from $\Delta T \approx 70$ K to 140 K), which means a higher temperature difference between the disc and the air results in a higher convective heat transfer from the disc to the air.

5 DISCUSSIONS

5.1 Comparison with steady-state method in cooling effect analysis

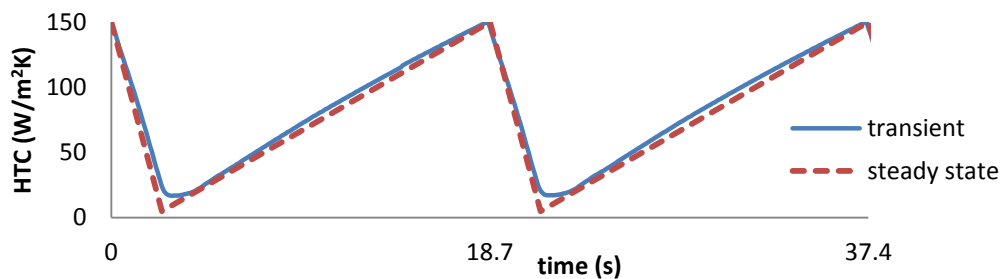

Figure 13: Area-weighted average disc HTC time course comparison between transient-state and steady-state analyses

The results for comparison of area-weighted average HTC time course between a transient-state CFD with a steady-state one are shown in Figure 13 for fixed disc temperature at 100 °C. Generally the difference in HTC result prediction between these two methods, i.e. transient-state and steady-state CFD, is not significant throughout the 10 heavy duty brake applications. As mentioned in section 4.1, even when the vehicle reaches zero speed, a residual velocity of remains which affects disc cooling, and this phenomenon can only be observed using the transient-state CFD method and consequently taken in consideration in the FEM. Moreover, the HTC distributions in acceleration and deceleration phases are different in the transient-state model. Thus, it can be seen that the transient-state CFD approach is more realistic than the steady-state one in cooling effect prediction.

5.2 Comparison of the disc temperatures obtained from different approaches

Figure 14 shows the comparison of maximum disc temperature obtained from the co-simulation methods, steady-state CFD method and the approach that applying area-weighted average HTC into FEM model. The experimental data from (3) is also included for benchmarking. The experiment data only had the disc surface temperature at the beginning and the end of individual brake application. And for comparison, the curve of experimental results is plotted using fitted curve method. In general, it can be seen that the for the maximum disc temperature prediction, the curves of these three simulation methods follows similar pattern. In terms of the temperature prediction at the end of each brake application (i.e. heating phase), the co-simulation method gives the closest value to the experiment data after the 5th brake application; at the beginning of each brake application (i.e. cooling phase) before the 8th brake application, the co-simulation method also shows the best performance. On the

contrary, the steady-state method has advantage in before the 5th brake application in heating phases and after the 8th brake application in cooling phases. The average-HTC applying method gives much higher temperature prediction in comparison with other methods as well as the experimental result. This is mainly due to its simplification of the HTC distribution description, which underestimated the HTC magnitude on surface area where the maximum temperature occurred according to Figure 11. In each cooling phase of the 10 braking cycles, the highest temperature drop was obtained from the co-simulation method, which indicates that this proposed method is more sensitive in disc surface cooling effect variation under such a complicated heavy duty braking condition in comparison with the other approaches mentioned.

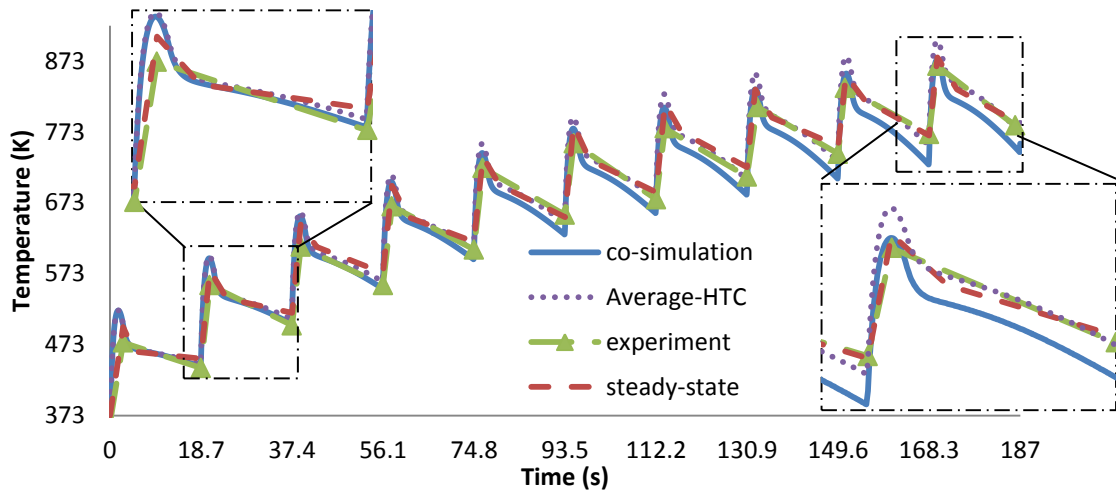

Figure 14: Co-simulation, steady-state method and experiment disc maximum temperature evolution time course

5.3 Comparison with one-way coupling in time efficiency

It is difficult to directly compare the computing time between one-way coupling and two-way thermally-coupled co-simulation methods. In the one-way method using steady-state CFD analysis as carried out in (3), the codes must be launched multiple times under different boundary conditions and the CFD and the FEM run separately. However, in the two-way CFD and FEM co-simulation presented in this paper, the analysis only runs once continuously and automatically to completion. As mentioned in section 3.1, the total run time of co-simulation is 92 min, and the independent run time without coupling for FEM model is 16 min while 75 min for transient CFD model throughout 10 brake application. It can be seen that the time required for the two-way data exchange using MpCCI is very insignificant (~ 1min) which reveals that this method is not as demanding on resources and computing time as anticipated. Comparably, the one-way coupling method using either steady-state CFD analysis (3) or transient CFD analysis (4) is much more time consuming in the aspects of models launching times and manual or semi-automatic data transfer procedures. Therefore, the two-way coupling method is more time efficient and convenient than the previous one-way coupling methods.

6 CONCLUSIONS

In this paper, in order to improve the time efficiency and prediction accuracy of ventilated disc brake thermal analysis, a two-way thermally-coupled FEM-CFD co-simulation method is studied. According to the results, the following conclusions can be drawn:

- 1) The coupling interface realized a high quality data mapping and exchange between FEM and CFD models automatically, with minimum time requirement.

- 2) The flow field results show two HTC distribution phenomena that cannot be observed in steady-state CFD method which implies the advantage in cooling effect prediction of transient CFD method and the corresponding co-simulation method.
- 3) The temperature results show the capability of the two-way co-simulation method in providing proper temperature field prediction.
- 4) The co-simulation system shows better time efficiency and convenience than the conventional one-way coupling methods and its resources demanding is much less than anticipated.

As it is known that there are many other influencing factors that can affect the accuracy when quantifying brake disc temperatures especially in the heavy duty brake application, such as thermoelastic instability (TEI) (10) and fluid-structure interaction (FSI) which have not been considered in the current study. However, due to the multi-physics coupling capability of the two-way coupling method, capturing TEI and FSI effects can be achieved by upgrading the complexity of the current co-simulation method. With the rapid development of computer performance, the two-way coupling method will be more tractable. Therefore, in future works, the feasibility and significance of multi-physics coupling method in braking research will be investigated.

ACKNOWLEDGMENT

The authors would like to appreciate Fraunhofer SCAI for their support of MpCCI license, the help of Dr. Fin Caton-Rose at the University of Bradford and the Euro-Brake review team for their constructive comments.

REFERENCES

- (1) Limpert, R., "Analysis and design of automotive brake systems", Society of Automotive Engineers, ISBN 1560912618, 1992
- (2) Brodbeck, C., "Code Coupling with MpCCI", Fraunhofer SCAI, Sankt Augustin, Germany, 2006
- (3) Pevec, M., Lerher, T., Potrc, I. and Vranesevic, D., "Numerical temperature analysis of brake disc considering cooling", *Advance Engineering*, 4(1), pp. 55-64, 2010
- (4) Belhocine, A. and Bouchetara, M., "Thermal Analysis of a Solid Brake Disc", *Applied Thermal Engineering*, 2012(32), pp. 59-67, 2012
- (5) <http://www.russellductile.co.uk/node/13>
- (6) Galindo-Lopez, C.H. and Tirovic, M., "Understanding and improving the convective cooling of brake discs with radial vanes", *Proceedings of the Institution of Mechanical Engineers, Part D: Journal of Automobile engineering*, vol. 222(7), pp. 1211-1229, 2008
- (7) ANSYS, Inc., "ANSYS FLUENT User's Guide", Release 12.0, 2009
- (8) Limpert, R., "Cooling analysis of disc brake rotors", SAE Technical Paper 751014, 1975
- (9) Li, L., Song, J., Li, Y., and Guo, Z., "Study on fast finite element simulation model of thermal analysis of vehicle brake", *Journal of system simulation*, vol. 17(12), pp. 2869-2877, 2005
- (10) Jacobsson, H., "Aspects of disc brake judder", *Proceedings of the Institution of Mechanical Engineers, Part D: Journal of Automobile Engineering*, vol. 217(6), pp. 419-430, 2003