

# bradscholars

## Energy monitoring and quality control of a single screw extruder

Item Type	Article
Authors	Deng, J.;Li, K.;Harkin-Jones, E.;Price, M.;Karnachi, N.;Kelly, Adrian L.;Vera-Sorroche, Javier;Coates, Philip;Brown, Elaine;Fei, M.R.
Citation	Deng J, Li K, Harkin-Jones E et al (2014) Energy monitoring and quality control of a single screw extruder. Applied Energy. 113: 1775-1785.
DOI	<a href="https://doi.org/10.1016/j.apenergy.2013.08.084">https://doi.org/10.1016/j.apenergy.2013.08.084</a>
Rights	© 2016 The Authors. This article is distributed under the Creative Commons CC-BY license ( <a href="http://creativecommons.org/licenses/by/4.0/">http://creativecommons.org/licenses/by/4.0/</a> )
Download date	2026-03-07 05:24:47
Link to Item	<a href="https://bradscholars.brad.ac.uk/handle/10454/10619.2">https://bradscholars.brad.ac.uk/handle/10454/10619.2</a>

# The University of Bradford Institutional Repository

<http://bradscholars.brad.ac.uk>

This work is made available online in accordance with publisher policies. Please refer to the repository record for this item and our Policy Document available from the repository home page for further information.

To see the final version of this work please visit the publisher's website. Access to the published online version may require a subscription.

**Link to publisher version:** <https://doi.org/10.1016/j.apenergy.2013.08.084>

**Citation:** Deng J, Li K, Harkin-Jones E et al (2014) Energy monitoring and quality control of a single screw extruder. *Applied Energy*. 113: 1775-1785.

**Copyright statement:** © 2016 The Authors. This article is distributed under the [Creative Commons CC-BY license](#).



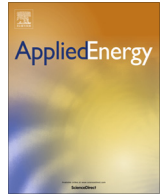

## Energy monitoring and quality control of a single screw extruder



Jing Deng<sup>a,\*</sup>, Kang Li<sup>b</sup>, Eileen Harkin-Jones<sup>a</sup>, Mark Price<sup>a</sup>, Nayeem Karnachi<sup>a</sup>, Adrian Kelly<sup>c</sup>, Javier Vera-Sorroche<sup>c</sup>, Phil Coates<sup>c</sup>, Elaine Brown<sup>c</sup>, Minrui Fei<sup>d</sup>

<sup>a</sup> School of Mechanical & Aerospace Engineering, Queen's University Belfast, Belfast BT9 5AH, UK

<sup>b</sup> School of Electronics, Electrical Engineering and Computer Science, Queen's University Belfast, Belfast BT9 5AH, UK

<sup>c</sup> School of Engineering, Design and Technology, University of Bradford, Bradford, West Yorkshire BD7 1DP, UK

<sup>d</sup> Shanghai Key Laboratory of Power Station Automation Technology, School of Mechatronical Engineering and Automation, Shanghai University, Shanghai 200072, China

### HIGHLIGHTS

- A simple real-time energy monitoring method has been developed for polymer extruder.
- The effect of process settings on energy consumption has been investigated.
- A complete monitoring and control system for polymer extrusion has been developed.
- A feedback control system based on fuzzy logic has been developed and validated.

### ARTICLE INFO

#### Article history:

Received 28 September 2012

Received in revised form 20 February 2013

Accepted 29 August 2013

Available online 26 September 2013

#### Keywords:

Polymer extrusion  
Single screw extruder  
Melt quality  
Fuzzy control  
Energy efficiency

### ABSTRACT

Polymer extrusion, in which a polymer is melted and conveyed to a mould or die, forms the basis of most polymer processing techniques. Extruders frequently run at non-optimised conditions and can account for 15–20% of overall process energy losses. In times of increasing energy efficiency such losses are a major concern for the industry. Product quality, which depends on the homogeneity and stability of the melt flow which in turn depends on melt temperature and screw speed, is also an issue of concern of processors. Gear pumps can be used to improve the stability of the production line, but the cost is usually high. Likewise it is possible to introduce energy meters but they also add to the capital cost of the machine. Advanced control incorporating soft sensing capabilities offers opportunities to this industry to improve both quality and energy efficiency. Due to strong correlations between the critical variables, such as the melt temperature and melt pressure, traditional decentralized PID (Proportional–Integral–Derivative) control is incapable of handling such processes if stricter product specifications are imposed or the material is changed from one batch to another. In this paper, new real-time energy monitoring methods have been introduced without the need to install power meters or develop data-driven models. The effects of process settings on energy efficiency and melt quality are then studied based on developed monitoring methods. Process variables include barrel heating temperature, water cooling temperature, and screw speed. Finally, a fuzzy logic controller is developed for a single screw extruder to achieve high melt quality. The resultant performance of the developed controller has shown it to be a satisfactory alternative to the expensive gear pump. Energy efficiency of the extruder can further be achieved by optimising the temperature settings. Experimental results from open-loop control and fuzzy control on a Killion 25 mm single screw extruder are presented to confirm the efficacy of the proposed approach.

© 2014 The Authors. Published by Elsevier Ltd. This is an open access article under the CC BY license (<http://creativecommons.org/licenses/by/3.0/>).

### 1. Introduction

Extrusion is regarded as one of the main processing stages involved in the manufacture of a wide range of thermoplastic products, including pipes, tubes, sheets and films. It is also an important

part of the injection moulding process. The single screw extruder is probably the most popular one used in the plastic industry [1]. The configuration of such an extruder is shown in Fig. 1, where polymer powder or granules is fed via the hopper and conveyed and melted along the screw and forced out through a die to achieve the desired form. During this process, the polymer undergoes complex thermal–mechanical transformations along with a change of the physical properties. Obviously, the screw is the key component in

\* Corresponding author. Tel.: +44 2890974480.

E-mail address: [j.deng@qub.ac.uk](mailto:j.deng@qub.ac.uk) (J. Deng).

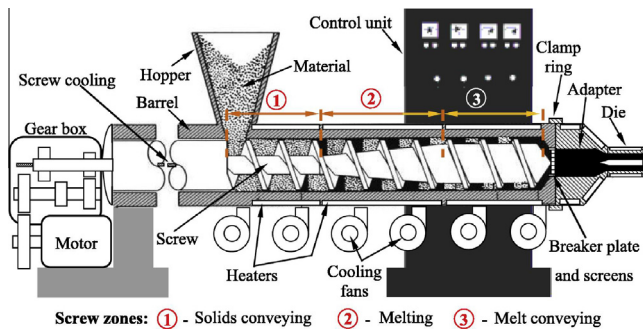

Fig. 1. The basic components and functional/geometrical zones of a single screw extruder [26].

extrusion process which has three main functional/geometrical zones: solids conveying, melting, and metering. The choice of screw usually depends on the material to be processed [2].

Although the light weight of plastic can help to reduce energy consumption in some industries, such as transportation and building, the processing of plastics is energy intensive. In the UK, the electricity bill for this purpose amounts to £380 million per annum. Thus, a reduction in electricity usage of 10% would result in savings of £38 million per annum and a significant reduction to environmental burden [3]. It has been shown that over 30% energy can be saved by taking action in management, maintenance, and capital investment [4]. Real-time monitoring of energy consumption then becomes necessary for studying the effects of operating settings on energy usage. Obviously, the use of a power meter (e.g. HIOKI 3169-21) is the easiest way to monitor power consumption, which includes the apparent power, active power, reactive power and the power factor. However, the installation of power meters for each extruder involves a large cost which might not be affordable for most SMEs. Mathematical models based on process settings seem to be an affordable alternative for such purpose [5,6]. However, the developed models depend on the geometry of the extruder and the materials being processed. It is difficult to use the same model on a different machine without re-training. In this paper, simple energy monitoring methods based on the controller variables will be proposed first, which do not need installation of extra power meters and the use of data driven models, thus enabling real-time monitoring and optimisation of energy consumptions.

In particular, given the real-time monitoring of energy consumption in polymer extrusion, the operating settings can thus be optimised according to several constraints among which the melt quality is perhaps the most important one. The quality can be indicated by the melt pressure, temperature, viscosity, or throughput at the end of extruder. These indicators can be regulated by open-loop tuning of the screw speed and the barrel heating settings. Practically, a data sheet of these settings is available for each plastic material, and these settings are not changed during the process. However, due to many uncertainties, such as inconsistent geometric and physical properties of polymer granules, wears on screw and barrel, and uncontrolled changes inside the barrel, there always exist large variations in the above mentioned variables, leading to inconsistent quality of the final product (e.g. thermal degradation, output surging, poor mechanical properties, dimensional instability, poor surface finish and poor optical clarity [1]). A large amount of material and energy can be wasted due to such quality issues. In sheet extrusion or medical pipe production where consistent melt pressure is very important, a melt pump (or gear pump) can be used. But the cost is unaffordable for many industrial companies. On the other hand, proper control of the melt pressure has been shown to be a cost-effective alternative to

mechanical volumetric pumps [7]. Therefore, a closed-loop control of the melt flow properties not only can improve the product quality, but also reduce the energy consumption [6].

While some researchers studied the effect of screw geometry on the melt flow quality [2,8], most published work concentrates on the modelling and control of melt properties by adjusting screw speed, barrel temperature settings, or material feed rate. In [9], the effect of screw speed to the melt temperature and the melt pressure was empirically modelled, both a PI controller and a self-tuning regulator for melt pressure control was designed. To control the melt temperature, linear-time series regression model is commonly used to assist the design of control for disturbance rejection [10,9,11,12]. In addition to the control of melt temperature, the melt thermal homogeneity was also shown to be a key factor both for the product quality and for energy consumption [13]. In [14–16], the effect of feed rate and screw speed on the melt temperature and melt pressure were studied on a twin-screw extruder. Four separate ARMAX (autoregressive moving average with exogenous input) models were built based on prior knowledge and system identification methods. A model predictive controller (MPC) was designed to control the melt temperature and melt pressure to obtain consistent melt quality. Unfortunately, all the above methods were developed under certain assumptions not easily reproducible in real processing, and the relevant results were either verified on simulation only or on a twin screw extruder with the correlations between the output variables being ignored.

Among the above mentioned flow variables, viscosity is the most difficult one to control as it is not directly measurable. An in-line viscometry (e.g. slit or capillary die, and torsional viscometers [17,18]) can be used to measure it based on the pressure drop and throughput, leading to its control design by either the traditional PID method [19] or fuzzy logic [20]. However, in-line viscometer is not suitable for industrial applications, either due to its high cost or its restriction to the main melt stream. By contrast, the recently proposed ‘soft-sensor’ approach provides a potential alternative to the viscometer [21–23]. However, its accuracy needs to be further improved before it can be adopted for real-time control.

In this paper, closed-loop control for melt pressure and melt temperature is developed based on fuzzy logic. There are at least two main advantages of using fuzzy control. Firstly, it is a model-free approach. The extruder can be regarded as a non-linear time-varying system which makes it difficult to build an accurate mathematical model. Secondly, correlations between melt flow variables can be easily incorporated into the fuzzy rules based on expert experiences. The experimental results of the developed controller on a Killion KTS-100 single screw extruder show that variation of melt pressure can be reduced to  $\pm 0.03$  MPa, and the variation of melt temperature is less than  $\pm 0.5$  °C.

The rest of this paper is organised as follows. Section 2 introduces some fundamentals of typical single screw extrusion, followed by the model-free, real-time monitoring of energy consumption for both thermal heating and the motor drive. An investigation of the effects of process settings on overall energy efficiency and melt quality is described in Section 3. Section 4 provides with the basic knowledge of fuzzy logic, and Section 5 describes the control system configuration of a single screw extruder, and illustrates the control performance of the developed system. Finally, Section 6 concludes the paper along with some suggestions for future work.

## 2. Low cost energy monitoring

Polymers are very poor conductors in nature, so are usually processed by an extruder instead of melted in a container by absorb-

ing heat only. During the extrusion process, the plastic granules moves from the feed zone to the die, and are melted by a combination of external electrical barrel heating and mechanical work from the screw. Generally, if the screw speed is low, the energy to melt the polymer granules is mainly from the barrel heating. If the screw speed is high, shear heating provided by the screw rotation becomes the main heating source. Therefore, optimal screw speed design is required to achieve an energy efficient extrusion process. Unnecessarily high barrel heating will cause a significant amount of energy being lost to the environment.

The extruder thermal profile over the length of the extruder is also regarded as a key issue relating to its energy efficiency and thermal inefficiencies can exist due to imbalanced power of the heating bands. On a Killion KTS-100 single screw extruder, the thermal profile during the extruder start-up is recorded and shown in Fig. 2. Here, zone 2 takes less time to reach the set point while the die is much slower to heat up. The slow temperature raise of zone 1 and zone 3 may be caused by other parts of the screw, such as the water cooling of the feed area near zone 1 and the heat transmission from zone 3 to the adapter and clamp ring. Theoretically, if the power of each heater band is properly selected, the machine start-up time can be reduced from 25 min to 10 min. This reduction would further lead to less material waste during production change period and less energy waste from the earlier heat-up components.

The heating zones along the barrel also have different effects on the melt temperature. This has been studied on the Killion KTS-100 single screw extruder which has three heating zones. Their effects are listed in Table 1, and these will later be incorporated into the design of fuzzy rules.

Melt pressure is normally proportional to screw speed, and change of screw speed will naturally introduce an over-shoot in the melt pressure. Any increase in melt temperature will decrease the melt pressure and the viscosity. In the extrusion process, melt pressure is easier to control due to its quick response to a change in screw speed. By contrast, the response of melt temperature to a change in barrel heater settings is much slower. The former is usually less than one second while the latter requires several minutes in our experiments.

**Table 1**

Effect of different heating zones on the melt temperature (a step change of 10 °C was applied separately on each heating zone, the screw speed was set at 20 rpm, temperature settings from zone 1 to die were 185–185–190–190–190–190 °C).

	Zone 1	Zone 2	Zone 3
Changes of melt temperature	1 °C	–6 °C	9 °C
Delay of effects	3.3 min	1.3 min	0 min

Compared to the melt pressure and temperature, viscosity is a better indicator of melt quality. It can be described as the resistance of material to flow, and is derived from the shear stress and shear rate of the flow as shown in (1)

$$\eta = \frac{\tau}{\dot{\gamma}} \tag{1}$$

where  $\eta$  represents the viscosity,  $\tau$  is the shear stress, and  $\dot{\gamma}$  denotes the shear rate. Shear stress is determined by the pressure drop in a slit die or capillary die, while the shear rate is proportional to the volumetric flow rate through the die. In this paper, a slit die is used and the viscosity can then be calculated using (2)

$$\eta = \frac{\Delta P W H^2}{12 L Q} \frac{3\bar{n}}{2\bar{n} + 1} \tag{2}$$

where  $\bar{n}$  is the power law index under the operating conditions,  $\Delta P$  denotes the pressure drop along the slit die,  $W$  and  $H$  are the slit width and height,  $L$  is the length between the two pressure points, and finally  $Q$  represents the volumetric flow rate. According to [19], throughput  $Q$  is related to the melt pressure and screw speed. For a low density polyethylene (LDPE), throughput can be approximated by a polynomial model with the order up to 2, the model fit error is less than 3%.

Real-time monitoring of the power consumption at each component is also desirable for optimising the overall energy efficiency. Instead of using a power meter or mathematical models, which are either expensive to install or not robust enough, simple methods based on the controller variables of thermal heating and motor drive can achieve accurate real-time monitoring of energy

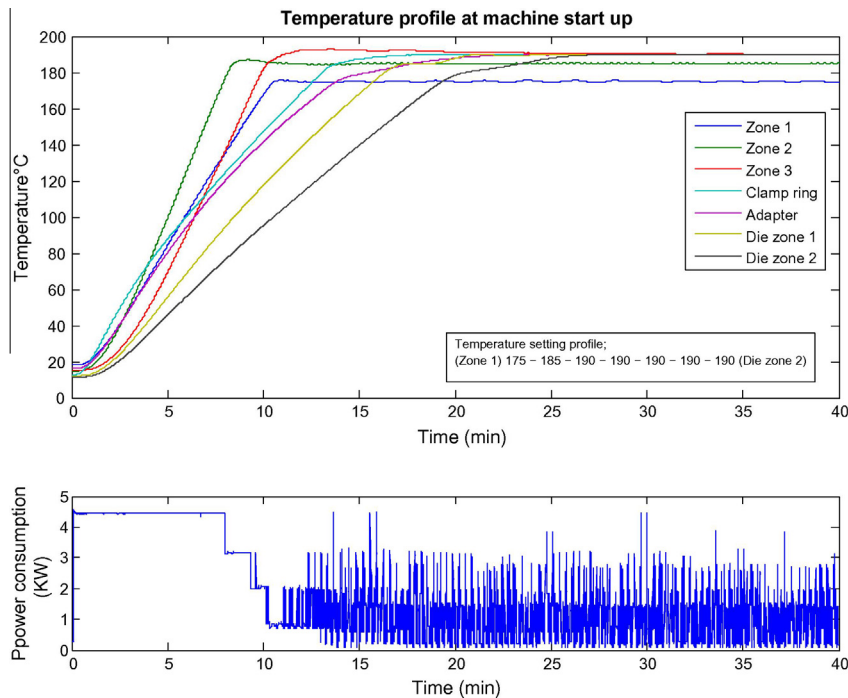

**Fig. 2.** Temperature profile at the extruder start-up (the bottom plot shows the total power consumption of the extruder).

consumption in extruders. The developed approaches were verified on a Killion KTS-100 single screw extruder located at Queen's University Belfast Polymer Processing Research Centre (PPRC).

This extruder is powered by a three phase electricity supply with each phase providing power to different components. Table 2 provides the phase configuration with the power of each component given in Table 3. Two HIOKI 3169 power meters are installed on this extruder to measure the total extruder power consumption and motor drive power consumption respectively to verify the proposed methods.

### 2.1. Monitoring of heating and cooling energy consumption

Extruders are usually fitted with temperature controllers. Temperature values are read from thermocouples, and the heating power is regulated through solid-state relays or contactors. A simple and effective PID (Proportional–Integral–Derivative) control algorithm is usually used for temperature control, and the controller output is incorporated with pulse width modulation (PWM) to regulate the relay or contactor. For the KTS-100 single screw extruder, zone 1–3 (solid conveying, melting, and metering) are fitted with both electrical heating and air fan cooling while other zones are fitted with heating only so the controller output has a range of  $[-100, 100]$  for the first three zones and  $[0, 100]$  for others.

The controller outputs for combined heating and cooling are illustrated in Fig. 3(a). A positive value of 50% means the heating is *on* for half of the cycle time and *off* for the other. This is equivalent to half of the maximum heating power. Similarly, a negative value of  $-60\%$  means the air fan cooling is *on* for 60% of the cycle time, which is equivalent to 60% of the cooling power. By contrast, the heating only controllers have positive outputs only, and the percentage of *on* time is equivalent to the percentage of maximum power applied to the heating band (see Fig. 3(b)).

Moreover, the control outputs are usually accessible through either digital (e.g. RS-422 serial communication or CAN bus) or analogue communication (e.g. 4–20 mA current or 0–10 V voltage). Therefore, by taking the controller outputs and their associated heating and cooling power, their energy consumption can be easily calculated as

$$P_{thermal} = \sum_{i=1}^5 p_i u_i \quad (3)$$

$$p_i = \begin{cases} p_{heating} & u_i \geq 0 \\ p_{cooling} & u_i < 0 \end{cases} \quad (4)$$

where  $p_i$  ( $i = 1, \dots, 5$ ) denotes the  $i$ th heating or cooling power, and  $u_i$  represents the  $i$ th controller output.

Fig. 4 compares the energy consumption measured using a HIOKI 3169-21 power meter and the proposed method. It is clear that the calculated value fits well with the measurements in the first 5 min. After this period, the calculated value is a little higher than the power meter measurements. This is caused by the lower

**Table 2**  
Three phases power supply to the KTS-100 single screw extruder.

Power phase	Supply to components
Phase 1	Controller circuits Zone 3 heating and cooling Motor drive power supply
Phase 2	Zone 1 heating and cooling Clamp ring heating
Phase 3	Zone 2 heating and cooling Adapter heating

**Table 3**  
Power consumption at each component in a single screw extruder.

Component	Power consumption (Kw)
Zone 1 heating band	1.296
Zone 2 heating band	1.267
Zone 3 heating band	1.238
Clamp ring heating band	0.496
Adapter heating band	0.106
Slide die zone 1 heating	0.235
Slide die zone 2 heating	0.650
Air cooling fan	0.0464
Temperature controller standby	0.0016
Other circuits	0.06

sampling rate of the power meter. Through serial communication, the maximum sampling rate of this power meter is 1 Hz while the sampling rate from the temperature controller was set at 10 Hz. In the first 5 min, the heater works at its full power, which can be confirmed by the slope of the curve in Fig. 4. However, after the warm-up period, the controller outputs change frequently in the range of  $[-100, 100]$  or  $[0, 100]$ . It is probable that the 1 Hz sampling rate is not capable of capturing all the changes and thus the resultant energy is lower than the actual value.

The proposed method also has the advantage in monitoring the energy usage for each heating zone. Fig. 5 shows the thermal energy consumption for each zone along the extruder. According to the recorded data, zone 1 consumes nearly half of the total thermal energy. This can be caused by the plastic granules absorbing heat energy when passing through zone 1. However, due to the higher heat conductivity of metal, a significant amount of energy is wasted in cancelling the zone 1 heating and feed area water cooling. This observation may lead to the conclusion that installation of a heat isolation plate between zone 1 and the feed section should help to significantly reduce the overall thermal energy consumption.

### 2.2. Monitoring of motor energy consumption

The motor drive controller also utilises PID control implemented through PWM. Rotational speed is measured by a tachometer, and the controller output is used to adjust either the frequency (for AC motors) or the armature voltage (for DC motors). In this study, a Eurotherm 512C motor drive is installed in the KTS-100 single screw extruder to drive a 2.24 kW DC motor. This controller provides several terminals which can be used to read or write the control variables through either analogue or digital signals.

Generally, the rotational speed of a DC motor is proportional to the motor armature voltage, and the rotational torque is proportional to the motor armature current. This relationship can be summarised as

$$V_a = R_a I + E_b \quad (5)$$

$$E_b = K_v \omega \quad (6)$$

$$T = K_m I \quad (7)$$

$$V_a = R_a I + K_v \omega \quad (8)$$

where  $V_a$  and  $R_a$  are the armature voltage and current,  $E_b$  is known as back Electro Motive Force,  $\omega$  represents the motor rotational speed, and  $T$  denotes the motor torque, finally,  $K_v$  and  $K_m$  are motor specific parameters which can be easily identified through the measurements of  $V_a$ ,  $I_a$ ,  $T$ , and  $\omega$ .

Although the motor armature voltage  $V_a$  cannot be directly obtained from the controller, it is easy to calculate this value from (8). To achieve this, a power meter can be used to measure  $V_a$ ,  $I_a$ ,

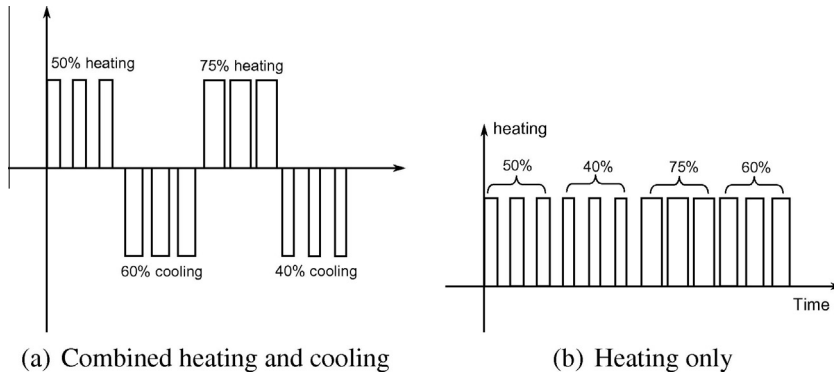

Fig. 3. Implementation of PID control by using pulse width modulation (PWM).

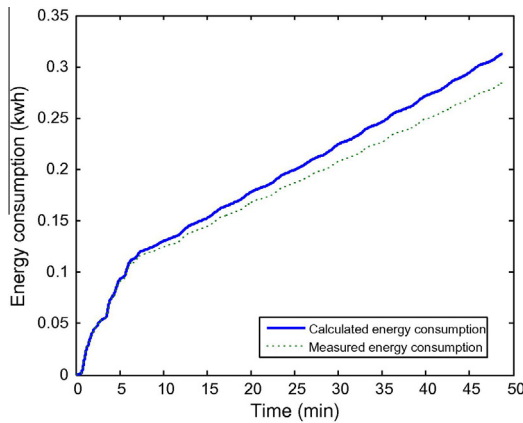

Fig. 4. Comparison of the thermal energy consumption monitoring by power meter (dotted line) and controller output calculation (solid line).

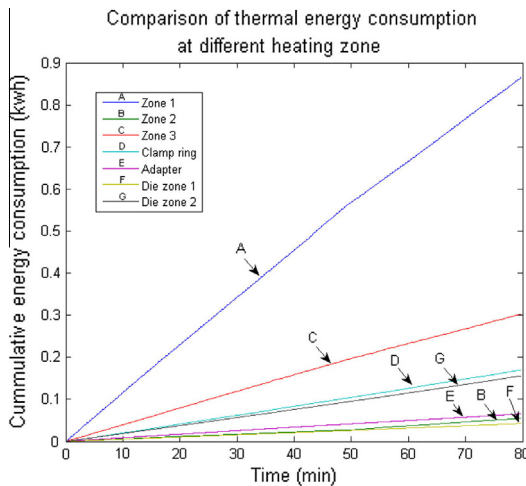

Fig. 5. Comparison of thermal energy consumption at different heating zone (LDPE was processed at 10 rpm, temperature settings were 170–180–190–190–190–190 °C from zone 1 to the die).

and  $\omega$  which is then used to estimate the unknown parameters  $R_a$  and  $K_b$ . Fig. 6 illustrates the performance of the developed linear model for the motor armature voltage approximation.

Normally, the power consumption of a DC motor can be obtained through the product of the armature voltage and current. However, as PWM regulation is adopted, the supply voltage and current change at each PWM cycle. This causes a phase shift between the voltage and current, leading to a low power factor

of the motor drive system. An additional power meter attached to the motor drive power supply can verify such an effect. As a result, the DC motor consumes more energy than it actually required to drive the screw. Thus, it is necessary to figure out its apparent power usage instead of the active power.

Through further analysis of the data, it can be seen that the product of armature voltage and current has a non-linear relationship with the active power consumption. By using a second order polynomial model, a perfect approximation can be observed (see Fig. 7).

The apparent power is, however, not easy to calculate directly. However, it can be obtained by the product of active power and power factor (PF) where the latter is found to have a linear relationship with screw speed. Fig. 8 illustrates the ability of this linear model to fit the data. The variations on original data can be regarded as measuring noise.

Through the above discussion, a full representation of the motor power consumption, including apparent power, active power, and power factor, can be obtained. The resultant real-time monitoring of motor energy consumption is then used for the investigation of optimal operating settings. Additionally, the gear box connecting the DC motor and the screw also involves energy loss due to lower transmission efficiency. As a result, it is recommended to use direct drive when possible.

### 3. The effects of process settings

As mentioned earlier, the motor drive consumes around 1/3 of the total energy used by the extruder while thermal heating uses the remaining 2/3. Therefore, substantial savings from the thermal

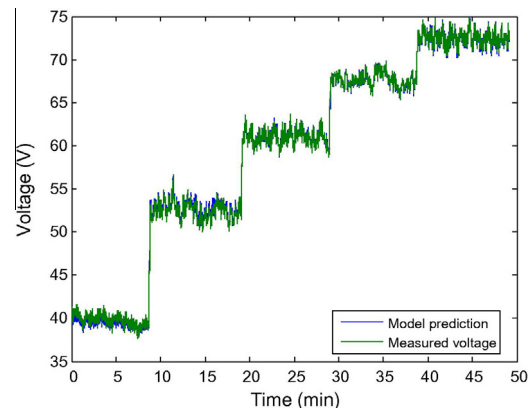

Fig. 6. Motor armature voltage approximation through a linear polynomial model  $V_a = 8.785I_a + 0.0038N$ , where  $N$  denotes the screw speed, which is equivalent to  $\omega$  regulated through a gear box.

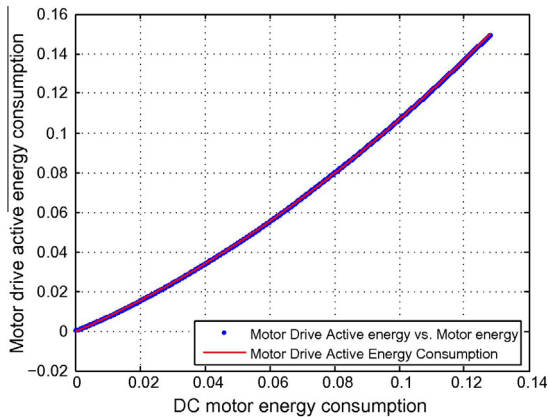

Fig. 7. Approximation of motor drive active energy consumption through 2nd order polynomial model  $y = 3.6x^2 + 0.71x$ , the  $R$ -square value is 1.

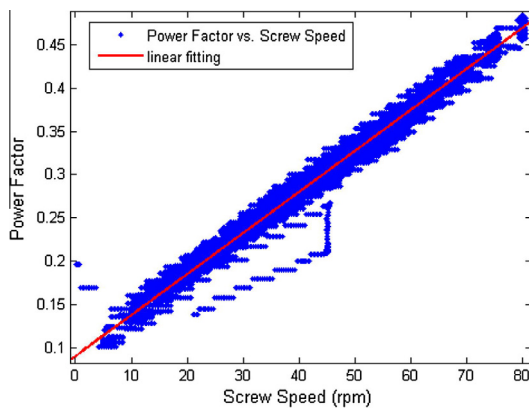

Fig. 8. Approximation of motor drive power factor by a linear model  $y = 0.00475x + 0.0898$ , the  $R$ -square value is 0.9921.

energy can be expected by properly selecting the operating parameters. Basically, the barrel and die heating temperatures, feed area water cooling temperature, and screw speed are the main adjustable variables. The following experiments investigate their effects on extrusion energy consumption and viscosity stability. All experiments (see Table 4) were carried out on the Killion KTS-100 single screw extruder and LDPE 2102TN00W from SABIC was used as the main test material. Viscosity was obtained through a slit die with a large width to height ratio [23].

### 3.1. Heating temperature settings

The processing window for polymer melting can be 50 °C or even more for some materials. A heater band temperature that is too low would result in the plastic granules not being properly melted, and more shear heating required, leading to greater energy consumption for the motor. By contrast, a higher heater band temperature increases the amount of energy lost to the environment. Thus an optimal setting not only saves energy, but also improves the melt quality.

The experimental heater temperatures were set at three different levels: A (low), B (medium), and C (high) as shown in Table 4. Each trial lasted around 90 min in which the first 30 min was allocated for the machine to reach its equilibrium point, and data was recorded for the remaining 60 min. The resultant total thermal energy consumption (from zone 1 to adapter), total extruder active energy consumption, motor drive active energy consumption, extruder power factor, motor drive power factor, ratio of zone 1

Table 4

Experimental settings of each test on the single screw extruder (the heaters after zone 3 were set the same temperature as zone 3).

DOE	Zone 1 (°C)	Zone 2 (°C)	Zone 3 (°C)	Screw speed	Water cooling (°C)
A	150	160	170	40	25
B	160	170	180	40	25
C	170	180	190	40	25
D	170	180	190	40	10
E	170	180	190	40	40
F	170	180	190	20	25
G	170	180	190	60	25

energy consumption to the total thermal energy usage, overall specific energy consumption, thermal specific energy consumption, and motor specific energy consumption are shown in Table 5 for each trial.

The thermal energy was calculated from the temperature controllers, and the total value is the summation from zone 1 to the adapter. As the heating of the slit die used a different power source to that of the extruder, its energy consumption is not considered in the results. The total thermal energy usage from seven trials is illustrated in Fig. 9.

From Table 5, it is clear that higher barrel temperature settings lead to higher thermal energy consumption but lower motor active energy consumption. However, the total specific energy consumption is increased at higher barrel heating temperatures. This suggests that lower barrel heating is preferred. On the other hand, as shown in Fig. 10, the viscosity decreased significantly when the heater temperature is changed from low to medium, but smaller differences occur between medium and high barrel heating. Further, the viscosity seems to be more stable at the higher heater temperature. However, the variations might be caused by noise on the pressure transducers. Referring to (2), the pressure (in MPa) is multiplied by a factor of  $2 \times 10^4$  while calculating the viscosity. In other words, a noise of 0.001 MPa would lead to an error of 20 Pa s on viscosity.

### 3.2. Feed area water cooling

The feed area water cooling temperature setting not only affects the extruder energy consumption, but also determines the chiller energy usage. It has been shown that increasing the flow temperature by 4 °C will decrease chiller operating costs by 10% [4]. The selection of chiller temperature setting should also consider the ambient temperature in order to save on cooling energy. For this KTS-100 single screw extruder, increasing water temperature reduces energy usage in both heater bands and motor drive (Table 6). However, the power factor slightly decreases. As the effects are small compared to barrel temperature settings, it might

Table 5

Effects of barrel temperature settings on energy consumption (data was recorded for 50 min, the sampling rate was 10 Hz).

	DOE A	DOE B	DOE C
Barrel temperature setting	Low	Medium	High
Total thermal energy (kw h)	0.808	0.910	1.000
Extruder active energy (kw h)	1.259	1.315	1.381
Motor drive active energy (kw h)	0.485	0.451	0.431
Extruder power factor	0.569	0.592	0.612
Motor drive power factor	0.419	0.412	0.406
Zone 1 vs total thermal	0.610	0.607	0.657
Total SEC (kw h/kg)	0.692	0.720	0.757
Thermal SEC (kw h/kg)	0.444	0.498	0.548
Motor SEC (kw h/kg)	0.266	0.247	0.236

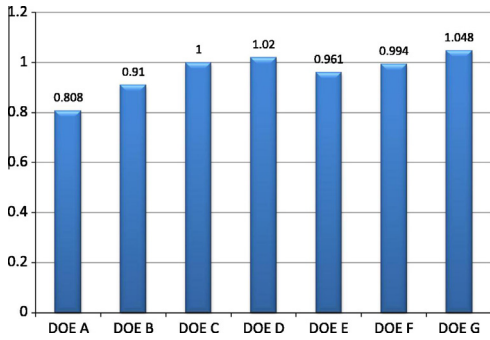

Fig. 9. Comparison of thermal energy consumption at different operational settings.

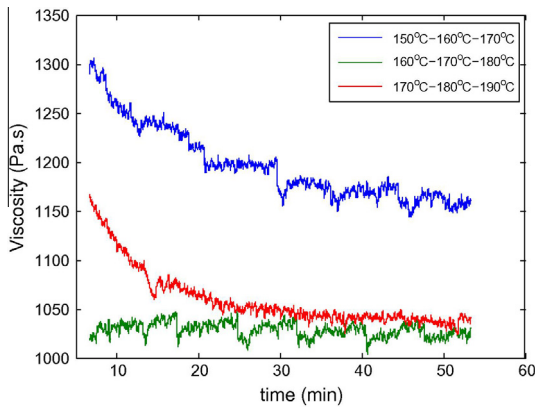

Fig. 10. Comparison of viscosity at different barrel heating settings.

Table 6  
Effects of water cooling temperature settings the energy consumption (data was recorded for 50 min, the sampling rate was 10 Hz).

	DOE D	DOE C	DOE E
Water cooling temperature	Low	Medium	High
Total thermal energy (kw h)	1.020	1.000	0.961
Extruder active energy (kw h)	1.403	1.381	1.345
Motor drive active energy (kw h)	0.435	0.431	0.427
Extruder power factor	0.616	0.612	0.606
Motor drive power factor	0.408	0.406	0.405
Zone 1 vs total thermal	0.667	0.657	0.644
Total SEC (kw h/kg)	0.772	0.757	0.736
Thermal SEC (kw h/kg)	0.561	0.548	0.525
Motor SEC (kw h/kg)	0.239	0.236	0.234

be reasonable to pay more attention to the chiller operating costs instead of the extruder while adjusting the water temperature settings. Additionally, Fig. 11 indicates that either too low water cooling or too high water cooling leads to lower melt viscosity. However, a periodic change of viscosity can be observed at higher cooling temperature. This might be caused by early raise of the granule temperature and a small plug of material forming inside the conveying zone. It is worth mentioning that the above characteristics were obtained from the KTS-100 extruder only. Future work will be carried out on different extruders under different materials.

### 3.3. Screw speed

There is no doubt that higher screw speed leads to lower energy consumption. According to the results in Table 7, screw speed has the most significant impact on thermal specific energy consumption (SEC). By contrast, the screw speed has a small effect on the

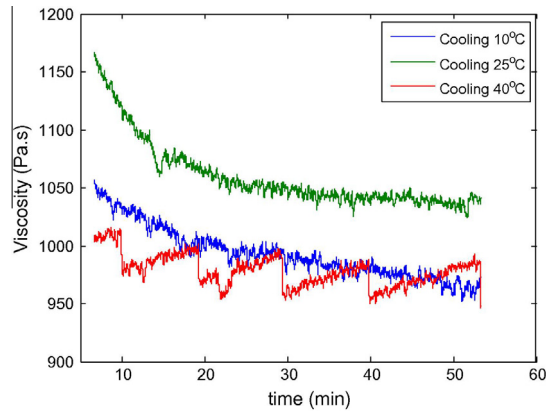

Fig. 11. Comparison of viscosity at different water cooling temperature settings.

motor SEC. A small decrease in power factor can also be observed when the screw speed is increased. For the melt quality, it is more stable at higher screw speed (Fig. 12). This suggests that the screw speed in an extrusion process should be set as high as possible to achieve higher throughput, better melt stability, and higher energy efficiency. For instance, increasing the screw speed from 20 to 40 would lead to a total saving of £1278 per year for this single small extruder (Calculation is based on Table 7, and the extruder processing 50 kg per day and 300 days per year, electricity price is £0.15 per unit). Most industrial production has much bigger extruders than this one, and usually 10–40 extruders are typical in a middle size company. At this scale savings of over £100,000 on annual energy bills could be achieved.

## 4. Preliminaries on fuzzy control

Fuzzy control is an expert system which uses a rule-based decision making scheme. It is based on traditional boolean logic, but allows partial membership in a set. A typical fuzzy logic controller consists of three components:

- Fuzzification, input values are associated with linguistic variables though membership functions. For example, the melt temperature of 190 °C can be regarded as low at 80% membership and medium at 20% membership.
- Rule design, this describes the relationship between input and output linguistic variables, such as “IF current temperature is low, THEN heater setting is high”.
- Defuzzification, the degree of membership of output linguistic variables within their linguistic terms are converted into crisp numerical values for controller output.

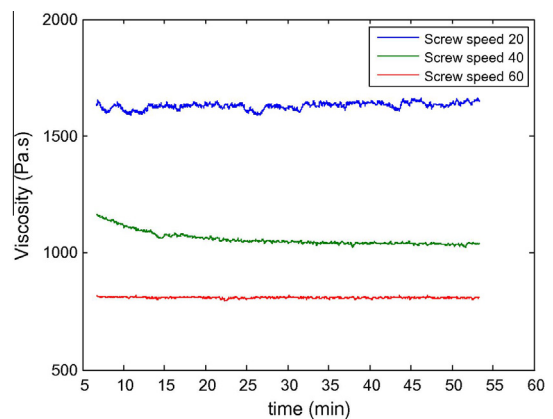

Fig. 12. Comparison of viscosity at different screw speeds.

**Table 7**  
Effects of screw speed on energy consumption (data was recorded for 50 min, the sampling rate was 10 Hz).

	DOE F	DOE C	DOE G
Screw speed	20	40	60
Total thermal energy (kw h)	0.994	1.000	1.048
Extruder active energy (kw h)	1.185	1.381	1.626
Motor drive active energy (kw h)	0.224	0.431	0.624
Extruder power factor	0.640	0.612	0.637
Motor drive power factor	0.301	0.406	0.500
Zone 1 vs total thermal	0.630	0.657	0.695
Total SEC (kw h/kg)	1.325	0.757	0.583
Thermal SEC (kw h/kg)	1.111	0.548	0.376
Motor SEC (kw h/kg)	0.251	0.236	0.234

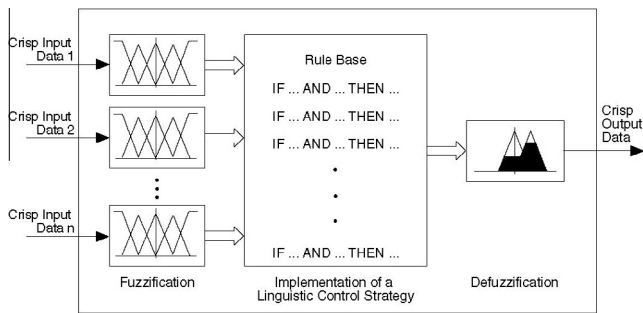

Fig. 13. The process of fuzzy logic control.

The process of fuzzy control is illustrated in Fig. 13 where a fuzzy PID controller can be easily developed by taking the process error and error changes as crisp inputs. The membership function can be chosen to have a triangular, trapezoidal, sigmoid, or Gaussian shape. In this paper, melt pressure and melt temperature are tackled simultaneously using the fuzzy controller. The number of fuzzy rules is therefore significantly increased from single variable fuzzy system. Specifically, the number of rules depends on both the

number of input linguistic variables and the number of linguistic terms associated with each variable. This can be simply calculated by

$$N = p_1 \times p_2 \times \dots \times p_n \tag{9}$$

where  $p_i$  is the number of linguistic terms for the input linguistic variable  $i$ . Therefore, the number of fuzzy rules is very sensitive to the input variables. In Labview 2011, the 'fuzzy system designer' from the 'PID and Fuzzy Logic Toolkit' can be adopted to build the rules (Fig. 14).

In this designer, the pressure error, change rate of pressure error, temperature error, and the change rate of temperature are four inputs, and the fuzzy controller outputs are adjusted values for screw speed and barrel heating temperature. As each of the four inputs is associated with 5 linguistic terms (see Table 8), total number of 625 rules are required to design this control system. This is difficult to implement due to the large number of rules. Fortunately, prior knowledge indicates that most of the rules are either not valid or redundant for this specific application, which brings down the number of rules to 156 for ease of implementation. One of those rules can be "if the pressure error is positive high and the change rate of pressure error is negative low and the temperature error is positive medium and the change rate of temperature error is positive low then the change of screw speed is negative medium and the change of barrel heating is negative medium".

**5. Experimental setup and results**

A Killion KTS-100 laboratory single-screw extruder located at Queen's university Belfast is used in this paper (Fig. 15). It is fitted with a 25.4 mm general purpose polyethylene screw which has a length-to-diameter ratio of 24:1. The screw is driven by a 2.24 kw vertical type permanent magnet direct current (PMDC) motor. Its full speed is 1750 rpm, however, a 15:1 ratio gear box is connected between the motor and screw, leading to a maximum screw speed of 116.7 rpm. The motor speed is controlled by a Parker 512C SSD driver, and the speed feedback is obtained through a

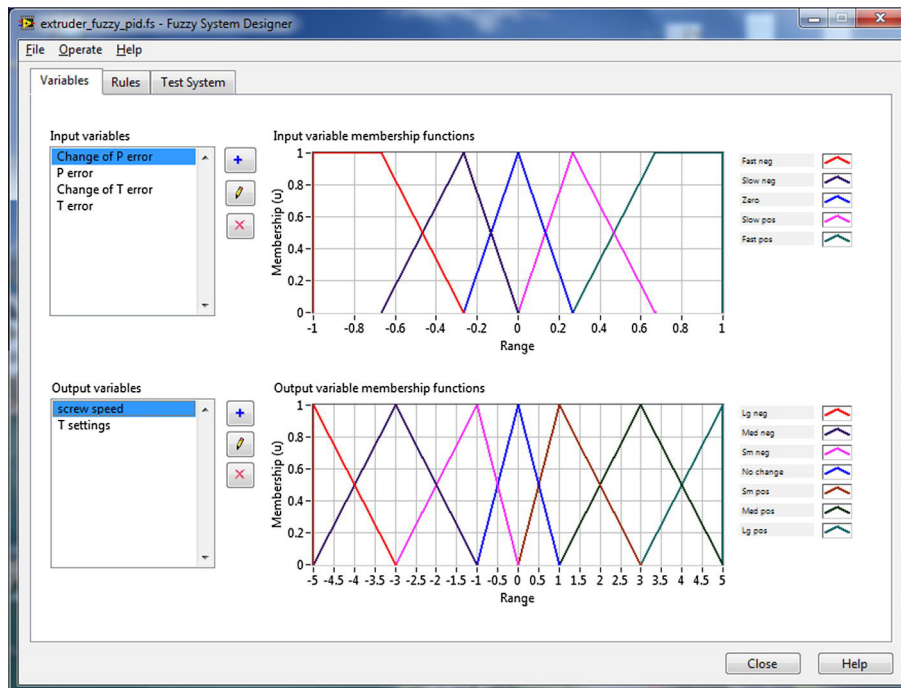

Fig. 14. Fuzzy system designer in Labview.

**Table 8**

Inputs and outputs of the fuzzy system ( $E_p$  denotes the melt pressure error,  $\Delta E_p$  is the change of pressure error,  $E_T$  and  $\Delta E_T$  are melt temperature error and the change of such error, respectively,  $\Delta N$  and  $\Delta T_b$  represent change of screw speed and change of barrel heating temperature, respectively. Meanwhile, “I” is short for “Input”, “O” is short for “Output”, “neg” is short for “negative”, and “pos” is short for “positive”).

Variables	I/O	Linguistic terms
$E_p$	I	High neg, Medium neg, Central, Medium pos, High pos
$\Delta E_p$	I	Fast neg, Slow neg, Zero, Slow pos, Fast pos
$E_T$	I	High neg, Medium neg, Central, Medium pos, High pos
$\Delta E_T$	I	Fast neg, Slow neg, Zero, Slow pos, Fast pos
$\Delta N$	O	High neg, Medium neg, Low neg Central, Low pos, Medium pos, High pos
$\Delta T_b$	O	High neg, Medium neg, Low neg Central, Low pos, Medium pos, High pos

Servo-Tek direct current tachometer. This motor controller also provides two analogue ports to measure and change the screw speed. The maximum voltage is 10 V which corresponds to the maximum speed of 1750 rpm.

There are seven heating zones in total on this extruder and each one is equipped with a Eurotherm 808 PID temperature controller. The location of all heaters is shown in Fig. 16 where zone 1 and zone 2 have four heating bands connected in parallel, and zone 3 has three heating bands connected in parallel. The corresponding heating power is shown in Table 9. The eurotherm 808 controller provides the RS-422 serial port, thus a RS-422 to RS-232 converter can be used to communicate between temperature controllers and computer.

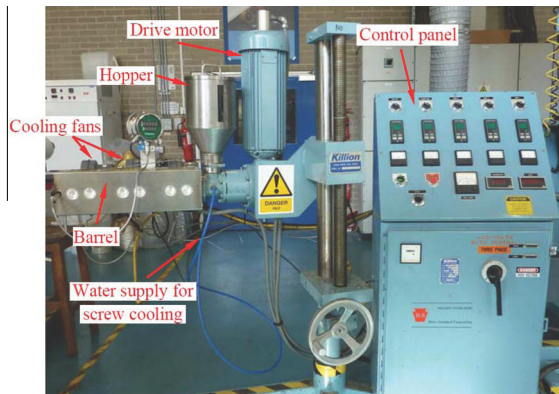

**Fig. 15.** Killion KTS-100 laboratory single-screw extruder located at Queen’s University Belfast, polymer processing research centre (PPRC).

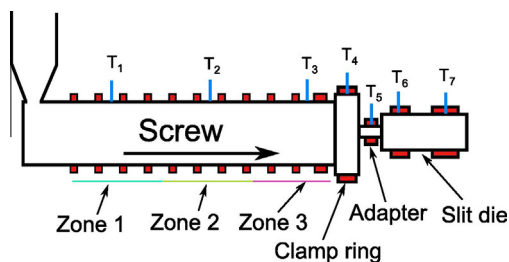

**Fig. 16.** Eleven heaters installed on the KTS-100 single screw extruder.

**Table 9**

Heating power of each zone on the KTS-100 extruder.

Location	Power (kW)	Location	Power (kW)
Zone 1	1.296	Clamp ring	0.496
Zone 2	1.267	Die zone1	0.235
Zone 3	1.238	Die zone 2	0.65
Adapter	0.106	Cooling fan	0.0464

The feed section is also cooled by a chiller to prevent early rise in polymer temperature which may result in a blockage in the feed opening.

In order to monitor the melt flow quality, several sensors are installed to measure pressure, temperature, and viscosity. The pressure at the barrel end is monitored by RT6s-7.5M-TCJ from ONEhalf20, this pressure transducer also has a built-in thermocouple to measure the temperature at the same location (Fig. 17). As the response of the thermocouple is a little slow (250 ms) for real-time control, an infrared melt thermometer IRTHERM 2003 from FOS Messtechnik GmbH is utilised, which has a short response time of 25 ms. The melt viscosity is monitored through a slit die with three pressure transducers (Onehalf20 RT-DLX-6S-3M-TCJ; Dynisco PT422a-1.5m-6/18, and a Dynisco TPT432A-1.5M-6/18) installed to measure the pressure drop. A precision scale is used to measure the throughput (extrudate was collected and weighed at every minute [24,21]).

All sensors are connected to the Compact Field Point 1808 data acquisition (DAQ) device from National Instruments. Currently, four I/O modules are installed, including the thermocouple input modules cFP-TC-120, strain-gauge input modules cFP-SG-140, analog input modules cFP-AI-100, and analog output module cFP-AO-210. The connection of each measurement is shown in Fig. 18 where the HIOKI 3169-21 is used to measure the power consumption of the extruder. In the computer, Labview 2011 from National Instruments is used for both data collection and control implementation. In order to prevent the effect of serial communication delay to the control algorithm, three while loops with different running rates are designed in the block diagram of Labview. The first loop is used for communication with eurotherm 808 controllers at an updating rate of 1 Hz. The second loop is designed for data recording and display of measured values at 10 Hz. The last loop is utilised for control algorithm at the same 10 Hz. All the values can be shared with other loop through local variables.

The fuzzy controller was implemented using Labview 2011, and tested on the Killion KTS-100 single screw extruder. Low density polyethylene (LDPE) was used as the processing material. At the

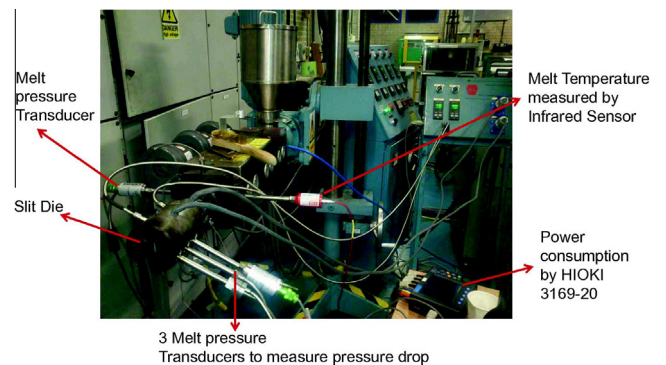

**Fig. 17.** Melt quality measurements at the KTS-100 extruder.

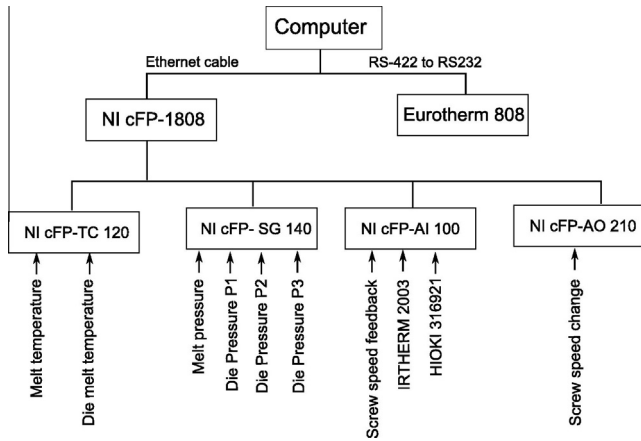

Fig. 18. Data acquisition system for the KTS-100 extruder.

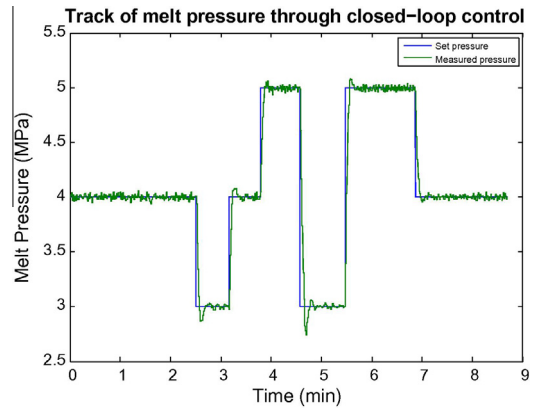

Fig. 20. Tracking performance of melt pressure (temperature setting profile is: 175–185–190–190–190–190 °C, the screw speed was automatically adjusted in the range of 5–60 rpm to obtain the desired melt pressure).

fuzzification stage, each input variable is assigned with five linguistic terms, and a triangular shaped membership function adopted. The Rules are designed based on previous experience. The outputs of the fuzzy control are screw speed and changes in temperature settings. However, the output for temperature settings is reduced to one to simplify the defuzzification process. This value is then weighted and added to the settings of each heating zone.

$$\Delta T_1 = 0.05T_c; \quad \Delta T_2 = -0.6\Delta T_c; \quad \Delta T_3 = 0.9T_c$$

$$T_i^* = T_i + \Delta T_i \quad \text{for } i = 1, 2, 3; \quad (10)$$

where  $T_c$  is the controller output,  $\Delta T_i$  represent the changes of settings for zone  $i$ ,  $T_i$ ,  $i = 1, 2, 3$  are the original settings, and  $T_i^*$ ,  $i = 1, 2, 3$  denotes their updated values. The output of the screw speed was also limited to  $[0, 50]$  while the output of the temperature change was limited to  $[-20, 20]$ .

In order to compare the control performance of the developed system, the variations of both melt pressure and melt temperature are illustrated in Fig. 19. As LDPE used in this paper is a very sticky material, large variations can be observed in the melt pressure. The

temperature variation is around 4 °C. However, if the screw speed changes significantly, the temperature variation will become larger.

Under closed-loop control, the above variations can be significantly reduced. As shown in Fig. 20, the pressure variation under fuzzy control becomes smaller than 0.03 MPa which is even smaller than using a gear pump (an average of 0.2 MPa pressure variations can be observed at the pump output in an industrial sheet extrusion line). The track of controlled pressure is very quick with a few seconds of settling time. As previously explained, the observed overshoot is naturally caused by the extruder structure instead of the controller. Fig. 21 also illustrates the performance of temperature fuzzy control. Due to the long delay for heat transfer, the settling time for melt temperature is nearly 6 min, but variations after this settling period become smaller than 0.5 °C. The PID controller was also tested on this extruder. However, a different material was used, so the results are not suitable for comparison. According to these implementations, the main drawbacks of PID control for polymer extrusion includes:

- The parameters of the PID controller require long time to adjust. Though there are some well-developed PID tuning algorithms, such as the Ziegler-Nichols method, the obtained controller does not perform well. A manual adjusting process is still required to achieve better control performance, and this process

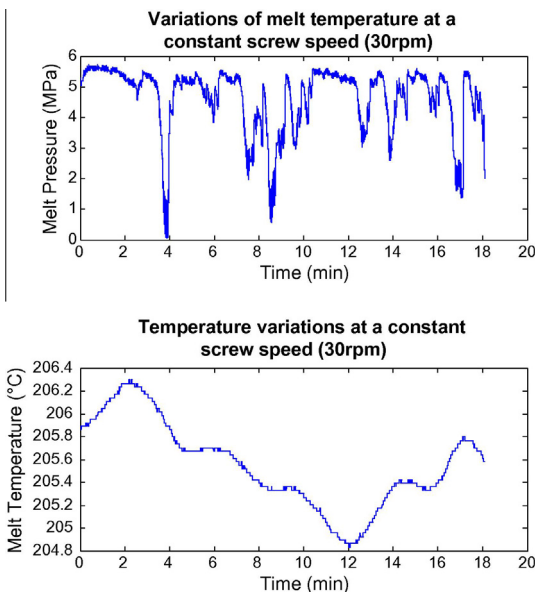

Fig. 19. Variations on the melt pressure and melt temperature (Screw speed is set constant at 30 rpm, temperature setting profile is: 175–185–190–190–190–190 °C).

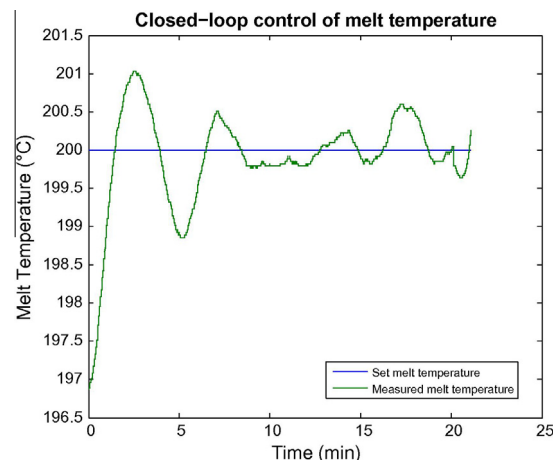

Fig. 21. Closed-loop control of melt temperature (Melt pressure is controlled at 3 MPa, temperature setting profile is: 175–185–190–190–190–190 °C).

is not only time consuming, but also leads to a waste of materials. By contrast, the membership function in fuzzy control is easier to adjust, and previous experiences can be incorporated.

- A PID controller lacks robustness. The tuned parameters are suitable for a specific working condition or particular material only. Either change can lead to a re-tuning process which is not suitable for industrial applications. Fortunately, fuzzy control is more robust to both internal and external conditions. This is due to the linguistic nature of fuzzy rules, which is independent of the process model.
- Multi-output is difficult to tackle in a PID controller. As previously mentioned, the melt outputs are correlated with each other, thus a multi-output controller is required to tackle them simultaneously. Unfortunately, the extension of a traditional single-input single-output PID algorithm to a multi-output system is difficult. Fuzzy control can easily solve this problem by incorporating these correlations into the rule design.

## 6. Concluding summary and future work

The energy efficiency of a polymer extruder can be improved by optimising the operating settings. This is based on the real-time monitoring of extruder energy consumption. In this paper, reliable and flexible approaches have been developed to obtain the power consumption due to thermal heating and the motor drive. The proposed methods have several advantages over conventional power meter or model-based monitoring, such as low cost, independence from extruder geometry and material being processed, and more accurate measurement due to high sampling rate.

A consistent melt quality is necessary as well as energy efficiency. Therefore, a rule-based fuzzy controller was designed for a single screw extruder to maintain the melt pressure and melt temperature at desired levels. In this paper, both the data acquisition hardware and Labview software from National Instrument are adopted for the control system design. A fuzzy controller is then developed with the assistance of 'Fuzzy system designer'. Experimental results shows that the pressure variation can be significantly reduced to  $\pm 0.03$  MPa while the melt temperature variation can be controlled within  $0.5$  °C.

In addition to melt pressure and temperature, viscosity is probably the best quality indicator. But it is also the most difficult one to measure due to the lack of sensors. In-line viscometer can be adopted, but the cost is too high and it also introduces restriction on the melt stream. The 'soft-sensor' approach may become an alternative to the viscometer, but its accuracy needs to be further improved. Future work will develop on-line optimisation techniques to improve energy efficiency based on the proposed monitoring and control scheme. Melt viscosity will also be incorporated into the fuzzy control system. This includes the accuracy improvement made to the 'soft-sensor' approach, leading to real-time monitoring of the melt viscosity. As increasing the number of input variables will significantly increase the complexity of fuzzy rule design, fuzzy rule selection techniques can be employed [25]. In the meantime, other intelligent control methods will be investigated, such as robust control or model predictive control (MPC). Also, as the proposed techniques have only been validated on the Killion extruder (from Davis-standard) located at PPRC, QUB. future work will also apply these techniques to other extruders with different configuration and communication protocols.

## Acknowledgments

This work was financially supported by Engineering and Physical Sciences Research Council (EPSRC) under Grant Nos. EP/G059489/1 and EP/F021070/1, and partly supported by Science and Technology Commission of Shanghai Municipality under Grant No. 11ZR1413100, National Natural Science Foundation of China under Grants 61271347 and 61273040, and Shanghai Rising-Star Program (12QA1401100).

## References

- [1] Rauwendaal C. Polymer extrusion. Hanser Gardner Pubns; 2001.
- [2] Kelly A, Brown E, Coates P. The effect of screw geometry on melt temperature profile in single screw extrusion. *Polym Eng Sci* 2006;46(12):1706–14.
- [3] Vera-Sorroche J, Kelly A, Brown E, Coates P, Karnachi N, Harkin-Jones E, et al. Thermal optimisation of polymer extrusion using in-process monitoring techniques. *Appl Therm Eng* 2013;53(2):405–13.
- [4] Kent R. Energy management in plastics processing. *Plast Rubber Compos* 2008;37 2(4):96–104.
- [5] Lai E, Yu D. Modeling of the plasticating process in a single-screw extruder: a fast-track approach. *Polym Eng Sci* 2000;40(5):1074–84.
- [6] Abeykoon C, McAfee M, Li K, Martin P, Deng J, Kelly A. Modelling the effects of operating conditions on motor power consumption in single screw extrusion, life system modeling and intelligent computing. *Lecture Notes Comput Sci LNCS* 2010;6329:9–20.
- [7] Previdi F, Savaresi S, Panarotto A. Design of a feedback control system for real-time control of flow in a single-screw extruder. *Control Eng Pract* 2006;14(9):1111–21.
- [8] Amano O, Utsugi S. Temperature measurements of polymer melts in the heating barrel during injection molding. Part 3: effects of screw geometry. *Polym Eng Sci* 1990;30(7):385–93.
- [9] Costin M, Taylor P, Wright J. On the dynamics and control of a plasticating extruder. *Polym Eng Sci* 1982;22(17):1095–106.
- [10] Hassan G, Parnaby J. Model reference optimal steady-state adaptive computer control of plastics extrusion processes. *Polym Eng Sci* 1981;21(5):276–84.
- [11] Dennis-Germuska D, Taylor P, Wright J. Adaptive and multivariable control of a single screw extrusion system. *Can J Chem Eng* 1984;62(6):790–801.
- [12] Lin Y, Lee G. System identification for state feedback integral observer control of polymer plastic extrusion. *Polym Plast Technol Eng* 1997;36(5):749–75.
- [13] Abeykoon C, Li K, McAfee M, Martin PJ, Irwin GW. Extruder melt temperature control with fuzzy logic. In: *Proceedings of the 18th IFAC world congress*; 2011. p. 8577–82.
- [14] Iqbal M. New approach to develop dynamic gray box model for a plasticating twin-screw extruder. *Ind Eng Chem Res* 2009;49(2):648–57.
- [15] Iqbal M, Sundararaj U, Shah S. Identification of transient responses of a plasticating twin screw extruder due to excitation in feed rate. *Polym Eng Sci* 2011;482–91.
- [16] Iqbal M. Advanced control of the twin screw extruder. Ph.D. thesis. University of Alberta; 2011.
- [17] Mansco Products. The TOV viscometer system in-line viscosity measurement; 2005. <<http://www.manscoproducts.com/index.htm>>.
- [18] Venkatraman S, Okano M. A comparison of torsional and capillary rheometry for polymer melts: The Cox-Merz rule revisited. *Polym Eng Sci* 1990;30(5):308–13.
- [19] Chiu S, Pong S. In-line viscosity control in an extrusion process with a fuzzy gain scheduled PID controller. *J Appl Polym Sci* 1999;74(3):541–55.
- [20] Chiu S, Pong SH. In-line viscosity fuzzy control. *J Appl Polym Sci* 2001;79(7):1249–55.
- [21] McAfee M. Soft sensor for viscosity control of polymer extrusion. Ph.D. thesis. Queen's University Belfast; 2005.
- [22] Liu X, Li K, McAfee M, Deng J. 'Soft-sensor' for real-time monitoring of melt viscosity in polymer extrusion process. In: *49th IEEE conference on decision and control (CDC)*; 2010. p. 3469–74.
- [23] Liu X, Li K, McAfee M. Dynamic grey-box modelling for online monitoring of extrusion viscosity. *Polym Eng Sci* 2012;52(6):1332–41.
- [24] Pabedinskas A, Cluett W, Balke S. Development of an in-line rheometer suitable for reactive extrusion processes. *Polym Eng Sci* 2004;31(5):365–75.
- [25] Zhao W, Li K, Irwin G. A new gradient descent approach for local learning of fuzzy neural models. *IEEE Trans Fuzzy Syst* 2013;21(1):30–44.
- [26] Abeykoon C. Modelling and control of melt temperature in polymer extrusion. Ph.D. thesis. Queen's University Belfast; 2011.