

The University of Bradford Institutional Repository

<http://bradscholars.brad.ac.uk>

This work is made available online in accordance with publisher policies. Please refer to the repository record for this item and our Policy Document available from the repository home page for further information.

To see the final version of this work please visit the publisher's website. Access to the published online version may require a subscription.

Link to publisher's version: <http://dx.doi.org/10.1016/j.apenergy.2016.07.014>

Citation: Abeykoon C, Kelly AL, Brown EC and Coates PD (2016) The Effect of Materials, Process Settings and Screw Geometry on Energy Consumption and Melt Temperature in Single Screw Extrusion. *Applied Energy*. 180: 880-894.

Copyright statement: © 2016 Elsevier Ltd. Reproduced in accordance with the publisher's self-archiving policy. This manuscript version is made available under the [CC-BY-NC-ND 4.0 license](#).



The Effect of Materials, Process Settings and Screw Geometry on Energy Consumption and Melt Temperature in Single Screw Extrusion

Chamil Abeykoon^{a,*}, Adrian L. Kelly^b, Elaine C. Brown^b, Phil D. Coates^b

^a*School of Materials, Faculty of Engineering and Physical Sciences, University of Manchester, Oxford Road, Manchester, M13 9PL, UK*

^b*IRC in Polymer Science and Technology, School of Engineering, Design and Technology, University of Bradford, Bradford, BD7 1DP, UK*

Abstract

Polymer extrusion is an energy intensive production process and process energy efficiency has become a key concern in the current industry with the pressure of reducing the global carbon footprint. Here, knowledge of the pattern of energy usage and losses of each component in the plant is highly useful in the process energy optimization. Moreover, it is essential to maintain the melt quality while improving the energy efficiency in polymer processing. In this work, an investigation was made on the total energy consumption, drive motor energy consumption, power factor and the melt temperature profile across the die melt flow (as an indication of the melt thermal quality) of an industrial scale extruder with three different screw geometries, three polymer types and wide range of processing conditions (altogether 135 different processing situations were observed). This aims to widen the knowledge on process energy and thermal behaviors while exploring possible correlation/s between energy demand and melt quality (in terms of melt temperature fluctuations across the melt flow). The results showed that the level and fluctuations of the extruder's power factor is particularly dependent upon the material being processed. Moreover, it seems that there is a relation between the level of energy demand of the heaters and the level of melt temperature fluctuations. While the extruder specific energy consumption decreases with increasing screw speed, specific energy consumption of the drive motor may have either increasing or decreasing behavior. Overall, this study provides new insights in a wide range on process energy demand and melt thermal quality in polymer extrusion. Moreover, further research is recommended to establish strong correlation/s between process energy consumption and melt thermal quality which should help to enhance process control and hence the product quality in single screw polymer extrusion.

Keywords: Polymer extrusion, Process monitoring, Energy consumption, Power factor, Energy efficiency, Melt temperature fluctuations.

1. Introduction

Polymeric materials are increasingly popular in industrial applications due to their properties including high strength to weight ratio, ease of forming into complex shapes, corrosion resistance, tunable color, tunable soft/hard touch and recyclability. Today, plastics (i.e., high performance polymers and composites) are invading diverse industrial sectors such as aerospace, automotive, marine, packaging and transportation, particularly due to the possibility of saving energy in comparison to several other conventional materials. For example, the replacement of a whisky bottle made out of glass with a plastic bottle would offer a significant weight reduction to the transport sector and this helps to save millions of litres of fuel all over the world annually [1]. Moreover, it is predicted that the use of polymeric materials will further increase in future [2]. Therefore, it is important to increase the energy efficiency of polymer processing while the lightness of polymeric materials would also save the energy. In industry, extrusion is one of the fundamental methods of processing polymeric materials

and most of the polymeric products pass through an extruder at least once in their production process. At present, polymer processing techniques are becoming highly important and widely available, and hence improvements to the process energy efficiency would provide a potential contribution for energy saving of polymer processing companies [3, 4] while reducing the global energy demand and harmful emissions to the environment. An extruder is a machine which melts polymeric materials while conveying along a screw and the heat for material melting is obtained externally from barrel heaters and internally from the frictional and viscous forces due to screw rotation. The molten material formed at the end of the extruder barrel is forced through a die to form into the desired shape. To achieve a good quality melt output, today extruders are equipped with a feed unit, an efficient drive, barrel/die heaters, screen changing device and various process monitoring and control devices. However, it is still highly challenging to observe the process melt quality as the material is being processed inside a closed barrel (an extruder is a kind of black box) [5]. More details on the machine, auxiliary equipment, process monitoring/control, functional requirements and the mechanisms/theories of polymer extrusion can be found in the literature [6, 7, 8, 9].

In general, plastics demand lower energies for their manu-

*Corresponding author

Email address: (Chamil Abeykoon)

43 facture, product fabrication, and also for recycling, than that 81
 44 demanded by other traditional raw materials, such as glass, 82
 45 aluminum and copper. According to Rosato et al. [10], plas- 83
 46 tics produce much more energy by incineration compared with 84
 47 other materials in municipal waste (compared with materials 85
 48 such as food waste, yard waste, wood, paper, and rubber). Cur- 86
 49 rently, plastics are a safe component in modern municipal waste 87
 50 incineration facilities with available high-tech pollution control 88
 51 devices. As almost all plastics are petroleum or natural gas 89
 52 derivatives, incineration can reduce the waste volume by 90-90
 53 98%, and convert the waste to useful energy. Furthermore, plas- 91
 54 tics have the lowest energy consumption in the recycling pro- 92
 55 cess compared to several other materials such as paper, glass, 93
 56 tin, aluminum, etc. However, still there is a possibility of im- 94
 57 proving the energy usage/demand of plastics processing tech- 95
 58 niques such as extrusion and hence further research is required 96
 59 in those areas. 97

60 1.1. Energy consumption in polymer extrusion 99

61 Usually, extrusion machines consume energy for the op- 100
 62 eration of the drive motor, barrel/die heaters, feeding units, 101
 63 compressors, pelletizers, screen pack changing devices, control 102
 64 electronics, and so forth. The typical energy demand and losses 103
 65 from a 63.5 mm diameter extruder relating to these components 104
 66 can be listed roughly as given in Table 1 [11]. 105

Table 1: Typical energy values for a 63.5 mm diameter single screw extruder 108
 [11] 109

Device	Energy input (%)	Energy losses (%)
Drive motor	76.2	14.0
Drive motor cooling fan	0.8	0.3
Rectifier cooling fan	0.2	1.0
Rectifier		8.0
Barrel heaters	18.6	8.0
Die/Adapter heaters	2.0	8.0
		0.4
Cooling water pump/Air cooling	2.0	1.0
Instrument panel	0.2	0.1
Gear box		4.0
Total energy input	100.0	37.0
Overall energy efficiency 63.0%		

67 In fact, these figures can be varied depending on the size/age 116
 68 of the machine, quality of the power supply, etc. In case of op- 117
 69 timization of the process energy efficiency, all the components 118
 70 attached to the machine should be considered. 119

71 1.2. Total power and motor power 120

72 Power demand of a direct current (DC) and an alternating 21
 73 current (AC) machine (P_{DC} and P_{AC}) can be given by equations 22
 74 1 and 2, respectively [12, 13]. 123

$$P_{DC} = V \times I \quad (1) 25$$

$$P_{AC} = V \times I \times \cos(\phi) \quad (2)$$

75 where, V is the line/supply voltage, I is the line/supply cur-
 76 rent and $\cos(\phi)$ is the power factor. The same equations can
 77 be used to calculate the power demand of DC and AC motors.
 78 In case of the motors with separate field, the addition of both
 79 armature and field powers should be taken as the total motor
 80 power.

Currently, both DC and AC motors are used in the extrusion industry. In the past, DC motors were popular due to the advantages of smooth operation over a wide speed range, simplicity of speed control, ability to produce a constant torque from zero to base speed, relatively lower power consumption and smallness in size compared to other types of drives with the same capacity. However, nowadays AC motors are becoming popular in particular due to better energy efficient operation (i.e., AC drives can operate at a constant power factor across the speed range) and also the requirement of less maintenance compared with DC motors.

DC motors are commercially available mainly under three categories: permanent magnet, separately excited and self-excited. Of these three categories, permanent magnet and separately excited DC motors may be the most commonly used in the polymer extrusion industry. The two main types of AC motors commercially available are induction motors and synchronous motors defined depending on the type of rotor used. Either type may be in the form of single phase, two phase, or three phase. A number of previous authors [14, 15, 16] have discussed the advantages of replacing DC motor drives with AC motor drives to benefit energy consumption. They performed experiments on the same extruder with AC and DC motors and found that a considerable amount of energy saving can be achieved with AC motors compared to DC motors. As they claimed, the replacement of old DC motors with new vector-controlled AC motor drives provide significant benefits in the long-run although the initial capital cost is higher for AC motors. It should be noted that the payback time period depends on the size of the motor and the type of the application.

In a typical AC motor, energy losses usually occur as electrical (or copper), core, mechanical and stray losses. In addition to these four types of losses, brush loss occurs in the DC motors which use brushes for supplying the power. More details on DC and AC motors can be found in the literature [12, 13].

1.3. Power factor

Usually, an AC power flow has three components known as real power (also known as active power) (P), measured in watts (W); apparent power (S), measured in volt-amperes (VA); and reactive power (Q), measured in reactive volt-amperes (VAR) as shown in Figure 1. The power factor is defined as the ratio of the real power flowing to the load, to the apparent power in the circuit and it ranges from 0-1. In other words, if ϕ is the phase angle between the current and voltage, then the power factor is equal to the cosine of the angle, $\cos \phi$ [12].

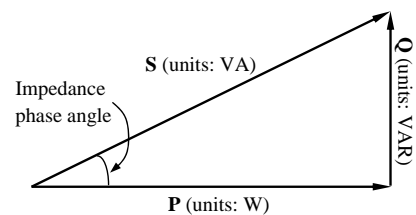

Figure 1: Power triangle: The components of AC power

For purely resistive loads, the current drawn by the load is a sinusoid which is exactly in phase with the voltage waveform and hence the power factor is unity. This is the most energy efficient operating condition. For inductive loads, the current will lag behind the voltage in phase, and hence the power factor will be less than one. Therefore, the energy supplied to the load will not be used optimally. As the mains voltage is fixed, a higher current is required from the power supplier (i.e., a high apparent power than usual) to compensate for the phase shift and deliver the same usable power to the load, bringing the active power back up to the level required to do the desired mechanical work. Here, the power supplier must build additional infrastructure to deal with low power factor conditions and pay for the higher apparent power. Therefore, an increase or a decrease of power factor is unrelated to active power. The active power may remain constant although power factor changes from 0-1 at a particular processing condition. As power factor increases (as the phase angle becomes smaller), it will cut down the apparent power demand and hence the consumer will not be charged by their power supplier for the reactive power. Therefore, maintaining the power factor at a high value is important for industrial processes to achieve an energy efficient operation. Usually, extrusion plants include both resistive and inductive loads. In the main, electric motors are inductive loads and hence their efficiency changes with power factor variations. Typical barrel/die heaters in the majority of extruders are resistive loads (i.e., based on resistive heating) and they operate with unity power factor. Given that the motor is a majority user of input power, it is clear that the power factor has a considerable effect on the process energy efficiency in polymer extrusion.

1.4. Previous studies on investigating of process energy consumption

Typically, extrusion is an energy intensive production process and the process energy efficiency is good at higher speeds. Regardless, it is difficult to run these processes at high speeds as thermal fluctuations increase with the processing speed resulting in very poor melt quality [17, 18]. A number of previous authors [19, 20, 21, 22, 23, 24, 25, 26, 27] have explored extruder total energy consumption while some of them have investigated the energy consumption of individual components such as drive motor and barrel heaters as well. A review on all major previous studies on process energy consumption in polymer extrusion was provided by the authors previously [28] and hence more details are not presented in this paper. Although the knowledge on possible correlations between the process energy demand and melt thermal quality is one of the major requirements in achieving both thermal and energy efficiencies simultaneously, no much attention has been paid so far into this area perhaps due to the possible complexity of such investigations. Some recent works by the authors [29, 28] explored the process energy consumption and met thermal quality in polymer extrusion and this work presents new results of their extended research activities.

This work aimed to study total power (TP), motor power (MP), power fluctuations (ΔP), power factor (PF) and specific

energy consumption (SEC) of an extruder over different processing conditions. Furthermore, the thermal homogeneity of the process melt output was explored in detail by observing the temperature profile across the output melt flow as an indication of the process melt thermal quality. Also, all the energy and thermal parameters were collected simultaneously and hence they can be compared each other for possible correlations. Three polymer types, three screw geometries and wide range of processing conditions (three different set temperature conditions over five screw speeds) were used for the experiments over the full processing range (screw speed) of the extruder (i.e., 135 different processing situations). All the experiments were performed by replicating actual processing procedures used in the industry. Extensive details of power demand/losses of the machine (i.e., total power, motor power and power factor and their fluctuations) and melt thermal quality (i.e., based on the temperature fluctuations across the melt flow) were explored to aid the optimization of process energy consumption and melt quality, simultaneously. Such a detailed investigation on process energy demand and melt thermal quality over wide range of materials, screw geometries and processing conditions is not available in the published literature.

2. Equipment, Materials and Procedure

All experiments were carried out on a 63.5 mm diameter (D) single screw extruder (Davis Standard BC-60) at the IRC laboratories of the University of Bradford. A gradual compression (GC) screw with 3:1 compression ratio, a tapered rapid compression (RC) screw with 3:1 compression ratio and a barrier flighted (BF) screw with a spiral Maddock mixer and 2.5:1 compression ratio were used to process the material. These screws were selected as these are the most commonly used types in industry and details are given in Figure 2. The extruder

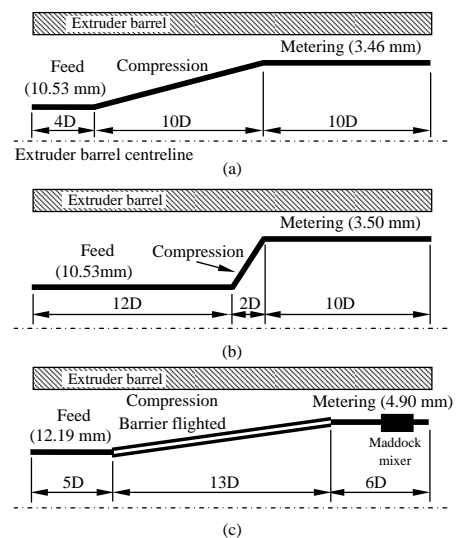

Figure 2: Details of the screws used in experiments

was coupled to an extrusion head containing a conical adaptor with 38 mm at the outlet by using a clamp ring prior to a short 6

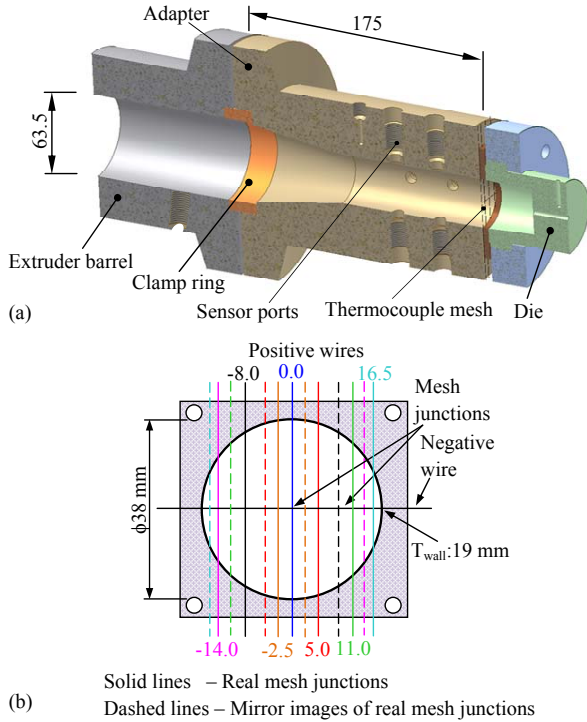

Figure 3: (a): the arrangement and the dimensions of the apparatus, (b): the thermocouple mesh arrangement

mm diameter capillary die as shown in Figure 3-a. The extruder barrel has four separate temperature zones (each with a heater of 4 kW) and another three separate temperature zones at the clamp ring (with a heater of 0.9 kW), adapter (with a heater of 1.4 kW) and die (with a heater of 0.2 kW). All of these temperature zones are equipped with temperature controllers which allows individual control of the set temperature of each zone. The extruder drive is a horizontal type separately excited direct current (SEDC) motor which has ratings: 460 Vdc, 50.0 hp (30.5 kW), at speed 1600 rpm. The motor and screw are connected through a fixed gearbox with a ratio of 13.6:1, and according to the manufacturers' information the gearbox efficiency is relatively constant at all speeds (~96%). The motor speed was controlled by a speed controller (MENTOR II) based on speed feedback obtained through a direct current (DC) tachometer generator.

Melt pressure was recorded using a Dynisco TPT463E pressure transducer close to the screw tip to observe the process pressure in real-time. The total extruder power, motor power and power factor relating the total power input to the extruder were measured using two Acuvim IIE three-phase power meters.

Melt temperatures at various different radial locations of the melt flow at the end of the adapter were measured using a thermocouple mesh [30] placed in-between the adapter and the die as shown in Figure 3. A thermocouple mesh with seven junctions (i.e., with 7 positive and 1 negative thermocouple wires) was used in this study and mesh junctions were placed asymmetrically across the melt flow along the diameter of the mesh as shown in Figure 3 (distance from the melt flow centreline

to each radial position: 0 mm, 2.5 mm, 5.0 mm, 8.0 mm, 11.0 mm, 14.0 mm and 16.5 mm).

A data acquisition programme developed using LabVIEW was used to communicate between the experimental instruments and a PC. All signals were acquired at 10Hz using a 16-bit DAQ card, National Instruments (NI) PCI-6035E, through a NI TC-2095 thermocouple connector box and a NI low-noise SCXI-1000 connector box.

2.1. Materials and experimental conditions

Experimental trials were carried out on an amorphous material [a virgin Polystyrene (PS)] and two semi-crystalline materials [a virgin low density polyethylene (LDPE) and a virgin linear low density polyethylene (LLDPE)] and the details of these materials' properties are given in Table 2. These materials were selected for the experiment as these are some of the most commonly used types in industrial applications.

Table 2: Details of the materials used for experiments

Property	Material		
	PS	LDPE	LLDPE
Trade name	Styrolution PS 124N	LUPOLEN 2420H	Flexirene CL10
Density (g/cm ³)	1.040	0.924	0.918
MFI @ (190 °C, 2.16 kg)	-	1.9 g/10min	2.6 g/10min
MVR @ (200 °C, 5 kg)	12 cm ³ /10min	-	-
Melt temperature (°C)	-	111	121
Vicat softening temperature (VST) (°C)	87	94	97
Characteristic of a crystal	Amorphous	Semi-crystalline	Semi-crystalline

During the experiments, the extruder barrel temperature settings were fixed as described in Table 3 under three different set conditions denoted as A (low temperature), B (medium temperature) and C (high temperature). These conditions were determined by covering the processing temperature ranges of the polymeric materials used in experiments.

Table 3: Extruder barrel temperature settings

Temperature settings	Set temperatures (°C)						
	Barrel zones				Clamp ring	Adapter	Die
1	2	3	4				
A	130	155	165	180	180	180	180
B	140	170	185	200	200	200	200
C	150	185	205	220	220	220	220

Twenty seven separate experimental trials (three materials × three screws × three set temperature conditions) were carried out with the three screw geometries. The data were collected at 0 rpm for a small time period. Then, the screw speed was adjusted from 10 rpm to 90 rpm in steps of 20 rpm. All data (i.e., pressure, melt temperature, total extruder power, motor power, power factor) were recorded continuously whilst the extruder was allowed to stabilise at each screw speed (i.e., at least around 8 minutes in each speed). Three samples of the mass throughput were collected during the last two minutes at each speed and the average values of these samples were used as the mass throughput at each processing condition. Then, the data collected during the last minute at each processing condition

were used for the analysis of steady-state conditions. The difference between the minimum and the maximum values within this time period was considered as the level of fluctuation of a particular parameter.

3. Results and Discussion

As was mentioned earlier, the data collected over the last minute at each processing condition are considered for the evaluations presented in this section.

3.1. Total power, motor power and power factor

The experimentally measured total power of the extruder (TP), magnitude of fluctuations of the total power (ΔTP), motor power (MP), magnitude of fluctuations of the motor power (ΔMP), difference between the total power and motor power (TP-MP), power factor (PF) and magnitude of fluctuations of the power factor (ΔPF) over the set temperature conditions A, B and C are shown in Figures 4, 5 and 6, respectively (note: PF details for PS is not available).

In this study, an amorphous and two semi-crystalline materials were used where these two types show distinct differences in their molecular structure. These differences can have a bearing on the performance of mouldings in service, and have a most significant effect on the behaviour of the material during processing [31]. In the solid state, the molecular structure of the amorphous materials is random and disordered, the long chain molecules being all entangled rather like solidified spaghetti. Semi-crystalline materials have a much more ordered structure in the solid state, a considerable proportion of the long chain molecules being closely packed in regular alignment. However, with both the semi crystalline and amorphous materials at sufficiently high temperature (this is when the material is in its molten state) the molecular structure is amorphous [31]. Of the three materials used in this study, in general, LLDPE shows the highest total power demand in processing at all the conditions. The major difference in LDPE and LLDPE is the degree of branching which dominates in determining their mechanical properties. LDPE is more crystalline than LLDPE as it contains fewer branches. Usually, LLDPE is less shear sensitive because of its narrower molecular weight distribution and shorter chain branching. During a shearing process, such as extrusion LLDPE remains more viscous and, therefore, harder to process than a LDPE of equivalent melt index. The LLDPE used in this study has a higher melt index (than LDPE) and a higher softening temperature (than both LDPE and PS). Therefore, these facts explain the higher energy demand of LLDPE compared to LDPE and PS.

In general, LLDPE shows the highest motor power demand too and a reduction of motor power can be observed with the increase of set temperature with all materials and screws. However, motor power fluctuations are significantly lower than the total power fluctuations. As was realized, the total power signal carries considerably high fluctuations due to the on-off of action of barrel heaters and cooling fans. With the screw speed, an

increasing trend can be observed from the motor power fluctuations which is an opposite behavior to the total power fluctuations. Both total and motor power signals show an increase with the screw speed and this increase shows a quite linear trend. Of the three materials, the difference between the total power and motor power (TP-MP) is the highest with the LDPE, regardless of the screw and set temperature condition, while PS is showing the lowest difference. Moreover, TP-MP has increased with the increase of the set temperature which should have occurred due to the increased energy demand of the heaters. Mostly, TP-MP reduced with increasing screw speed from 10-90 rpm while this has happened 30-90 rpm in a few occasions. Usually, the difference between the total and motor power signals is the power consumed by the process heating/cooling system, control electronics and other auxiliary equipment. In this study, no auxiliary equipment was employed and hence TP-MP values show the power consumed by the process heating/cooling system only (as the typical power consumption of the control electronics is very low at approx. 0.35 kW). As the same experimental set conditions were used with all materials, it is clear that the heat demand from the heaters are dependent upon the material type. This dependency should be related to the differences of process internal heat generation with the varying nature of the frictional and viscous properties of the materials. The higher the level of internal heat generation the lower the power demand of the barrel heaters. Moreover, the material's softening temperature should also affect on the level of heater power demand during its processing. As shown in Table 2, LLDPE shows the highest softening temperature although LDPE has demanded the highest heater power (TP-MP). This suggested that the heater power demand depends not only on the material melting temperature and hence it occurs via a more complex mechanism, including frictional properties. This is one of the areas which little attention has been paid so far (although highly important in energy saving) and hence further research should be highly useful in understanding the factors deciding the heater power demand during processing.

The power factor of the extruder has increased with the screw speed and this confirms that that the machine's energy efficiency increases with the screw speed. Moreover, the power factor fluctuations show a reducing trend with the screw speed and this is also important for improved energy efficiency. However, the power factor has not increased over 0.8 at any of the processing conditions tested in the experiments. The motor drive of the experimental extruder has a maximum speed of 116 rpm where the experiment trails were performed covering the 0-90 rpm speed range which may be one of the reasons why the power factor only goes up to 0.8. In fact, operating the process over 90 rpm would be energy efficient but it is highly likely to result un-melted materials with the process output leading to a poor melt quality. Moreover, it is noticeable that the machine has operated at a higher power factor with the LDPE than the LLDPE although the same processing conditions were used with both materials. As was mentioned, total power demand is higher with the LLDPE than the LDPE. This lower power factor condition with LLDPE would be expected to demand a high level of active power during the processing of LLDPE. How-

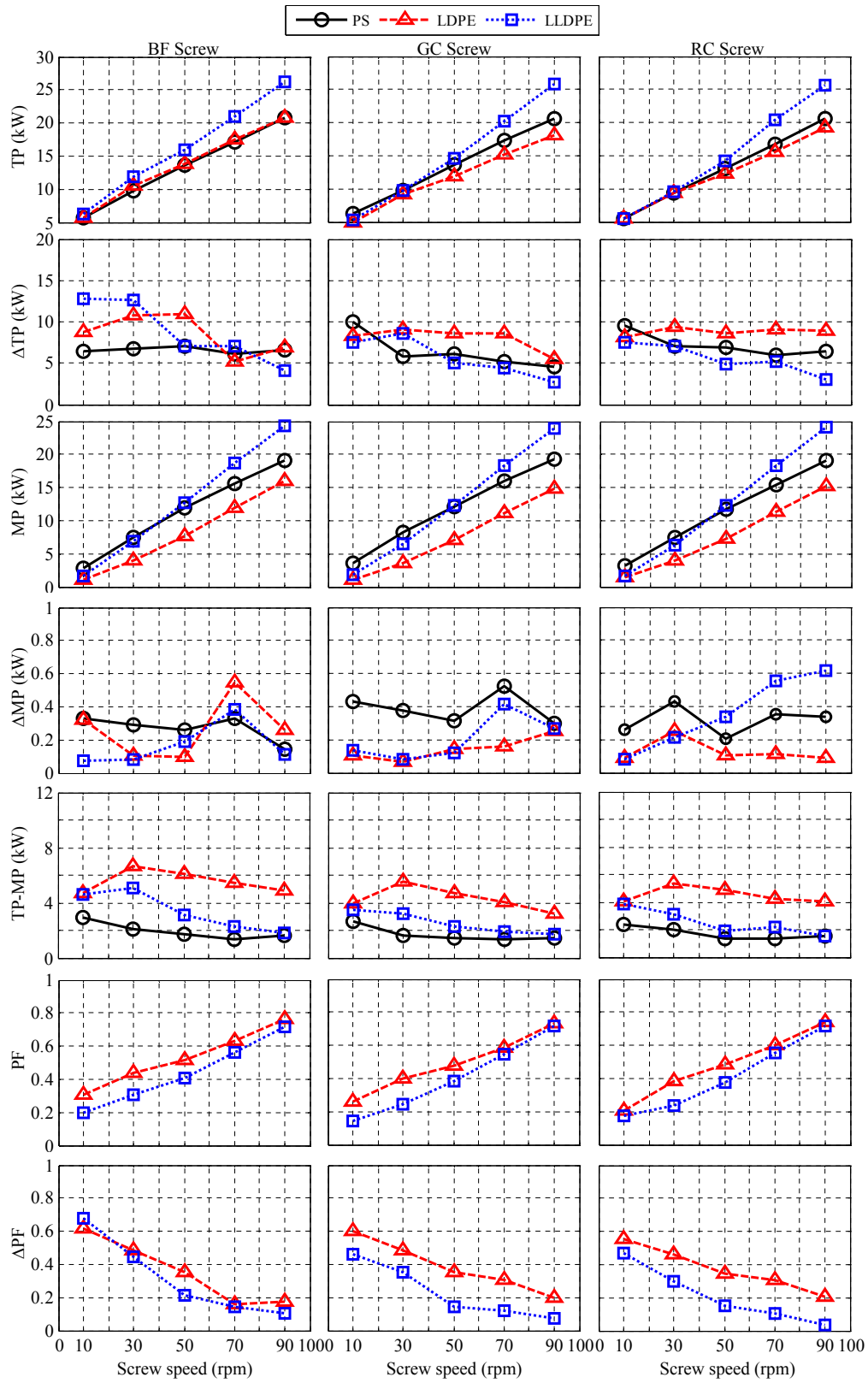

Figure 4: TP, ΔTP , MP, ΔMP , TP-MP, PF and ΔPF under the set temperature condition A

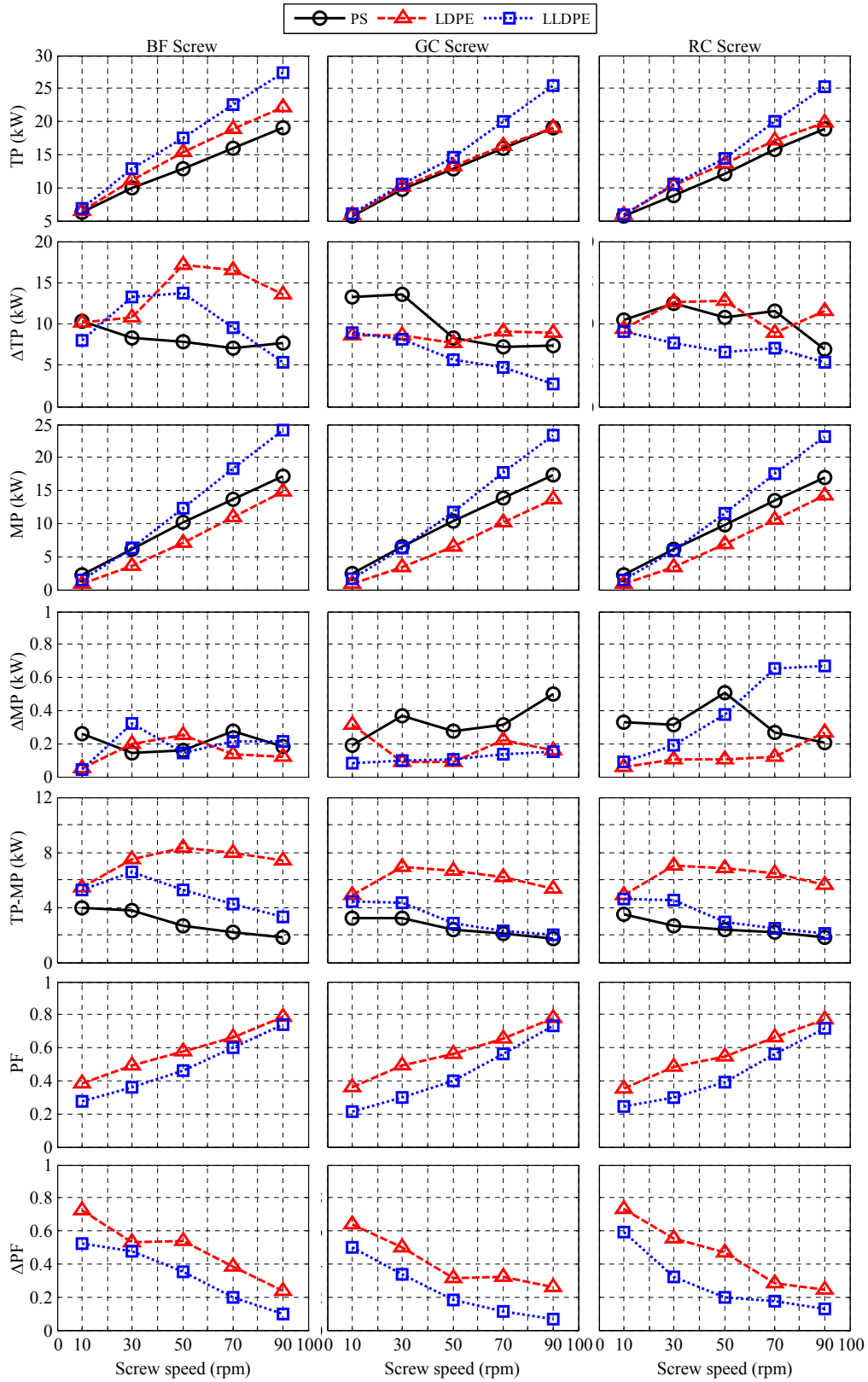

Figure 5: TP, ΔTP , MP, ΔMP , TP-MP, PF and ΔPF under the set temperature condition B

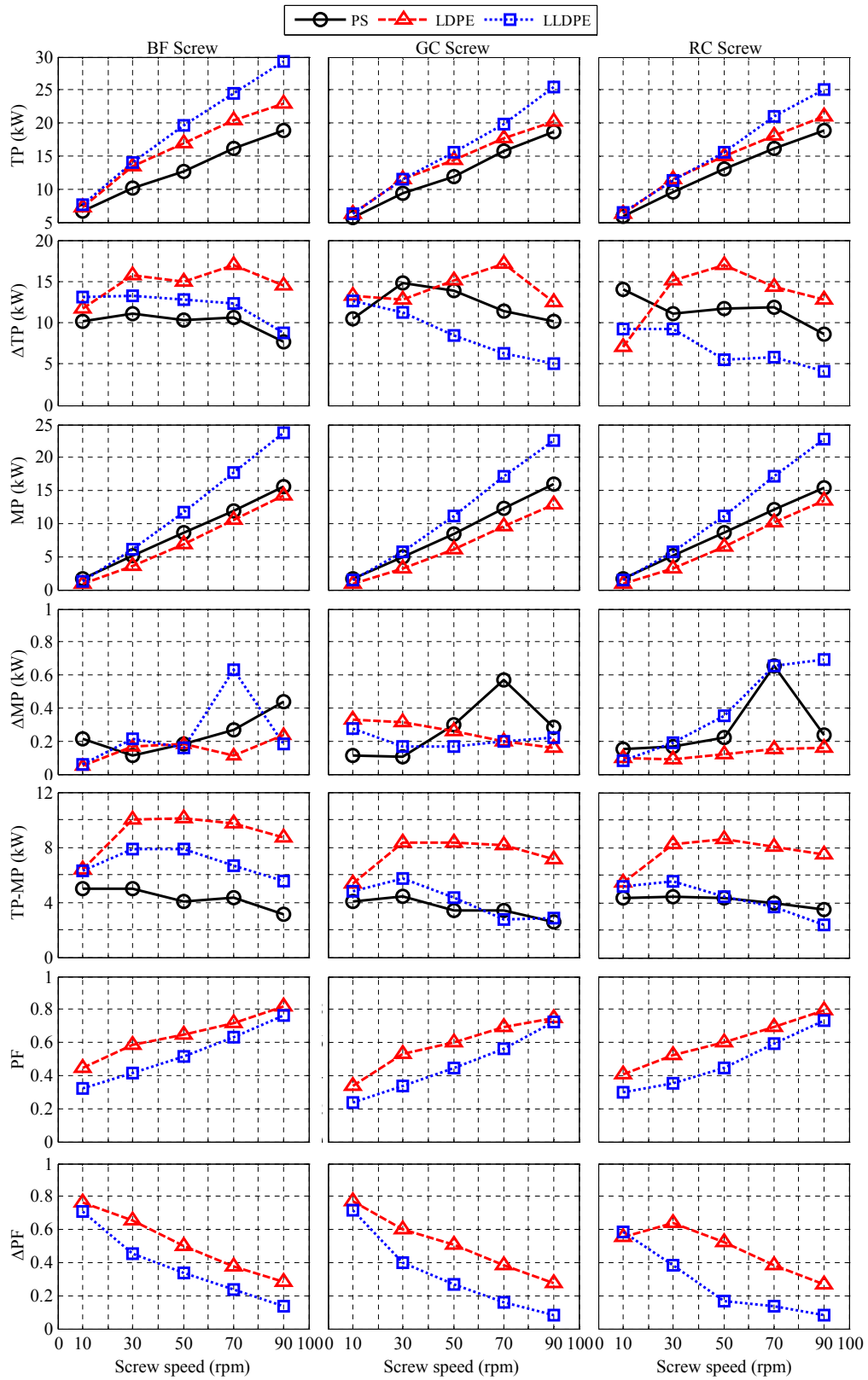

Figure 6: TP, ΔTP , MP, ΔMP , TP-MP, PF and ΔPF under the set temperature condition C

ever, the power factor fluctuations are higher for LDPE than the LLDPE. In fact, the power factor variations should be mostly related to the drive motor as it is the largest inductive load in the machine. Here, it is clear that the level of the power factor and magnitude of variations are depended upon the material type. Obviously, these behaviors should have some relations with frictional properties, shape/size of the pellets and the melt viscosity of the processing materials. The exact reason/s for such behaviors would be explored from further investigations.

3.2. Specific energy consumption

Experimentally measured mass throughput (MT), specific energy consumption of the extruder (SEC-Extruder) and specific energy consumption of the motor (SEC-Motor) over the set temperature conditions A, B and C are shown in Figures 7, 8 and 9, respectively.

Mass throughput of all the materials show a linear relationship with screw speed regardless of the differences of the screw geometry. Although the same processing conditions were used for these set of experimental trials, slight differences in the level of mass throughput can be observed among the materials even for the same screw geometry. Such differences occur due to the differences of the rheological properties of the materials [20] while conveying efficiency of the each screw might be another factor influencing the mass flow rate. Specific energy consumption of the extruder reduces with the screw speed at all the processing conditions and PS shows the lowest SEC-Extruder among three materials. This also confirms that energy efficiency of the extruder increases with the screw speed as confirmed by previous experiments [32, 29, 28, 18]. PS is an amorphous material and its softening temperature is lower than LDPE and LLDPE [33], and this explains how PS has consumed a lower power than LDPE and LLDPE. The magnitude and trend of SEC-Extruder with both LLDPE and LDPE are quite similar at all the processing conditions although LDPE dominates in the heater power while LLDPE is dominant in motor power. Previous work by Deng et al [34] found that the lower barrel heating temperature, higher water cooling temperature, and higher screw speed will lead to lower specific energy consumption of the extruder. However, the results of this work are not in agreement with these facts relating to the barrel set temperature. In this study, three set temperature conditions were used (A: low, B: medium, C: high) and for some conditions the lowest set temperature condition shows the highest SEC-Extruder. For example, the highest energy consumption at 10 rpm with GC screw for PS is at set temperature condition A. Therefore it seems that the relationship between SEC-Extruder and the barrel set temperature is highly complex in nature and further experiment should be useful in better understudying of these effects.

Specific energy consumption of the motor shows a highly variable nature depending on the processing conditions, material and screw geometry. In general, SEC-Motor increases for LDPE and LLDPE with all the processing conditions while it reduces for PS with the GC and RC screws at the set temperature condition A and also with the GC screw at the set temperature condition B. Likewise, SEC-Motor with PS are almost

identical at all the screw speeds with the RC screw under set temperature condition B. Usually, amorphous chains become immobilized and rigid and behave like glass below their glass transition temperature (T_g) and they lose their strength quickly above T_g [35]. However, at this stage, it is not that clear about the varying nature of the SEC-Motor for PS and further investigations should be made to understand this phenomenon. As was mentioned, SEC-Extruder with LDPE and LDPE are quite similar in trend and magnitude in all the processing conditions while the SEC-Motor shows a similar trend but with a significant deference in magnitude. The SEC-Motor is always higher for LLDPE than LDPE where the gap increases with the processing speed. Mass throughput is always higher for LLDPE than LDPE and hence the higher SEC-Motor is due to the LLDPE's dominance in motor power demand than LDPE which dominates in the heater power demand with a considerable offset to LLDPE.

3.3. Process thermal stability: magnitude and fluctuations of the temperature across the melt flow

The data collected from the thermocouple mesh during the last minute of operation at each screw speed (i.e., after the process became steady) were observed in order to study the process thermal stability. The minimum (Min), average (Avg) and maximum (Max) melt temperatures across the melt flow at each radial position were calculated and the corresponding temperature profiles across the melt flow are given in Figures 10, 11 and 12 under the set temperature conditions A, B and C, respectively.

In general, melt temperature fluctuations are not that significant at low screw speeds (10 rpm and 30 rpm) with all the processing conditions. However at high screw speeds, the BF screw clearly shows the lowest magnitude of fluctuations of the melt temperature at all the conditions regardless of the material being processed. Usually, BF screws perform favourably (e.g., efficient melting and mixing) compared to conventional single-flighted screws particularly due its specific design with melt-solid separation and mixing of the melt [32, 36]. Moreover, there is a clear increase of thermal fluctuations as screw speed increases with all the screws. Of these three materials, LLDPE shows the highest level of melt temperature as was expected (LLDPE having the highest melting temperature as shown in Table 2) and also the power demand for LLDPE processing is relatively higher than for PS and LDPE. The temperature of the PS and LDPE melts at some of the radial locations drops below the die wall set temperature with the GC and RC screws at 90 rpm for all the set temperature conditions. Temperature of the LDPE melt has also gone below the die wall set temperature at 70 rpm, with the GC and RC screws, at all the set temperature conditions but only at the set temperature condition C for PS. However, temperature of LLDPE melt are always higher than the die wall set temperature for all the conditions tested regardless of the screw, set temperature and speed. That means LLDPE does not show a low temperature shoulder region which is a kind of a good indication of better melting/mixing. As was explained in section 3.1, LLDPE shows the highest energy demand for processing among the three materials tested

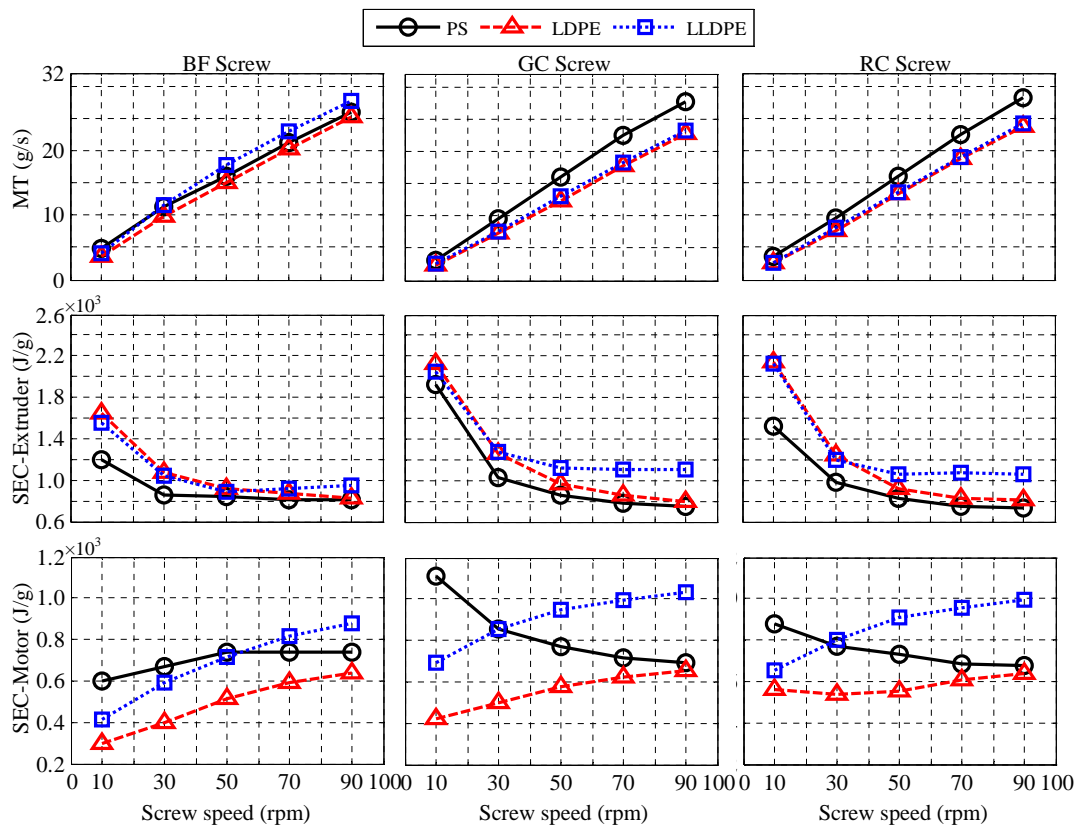

Figure 7: Mass throughput, SEC-Extruder and SEC-Motor under the set temperature condition A

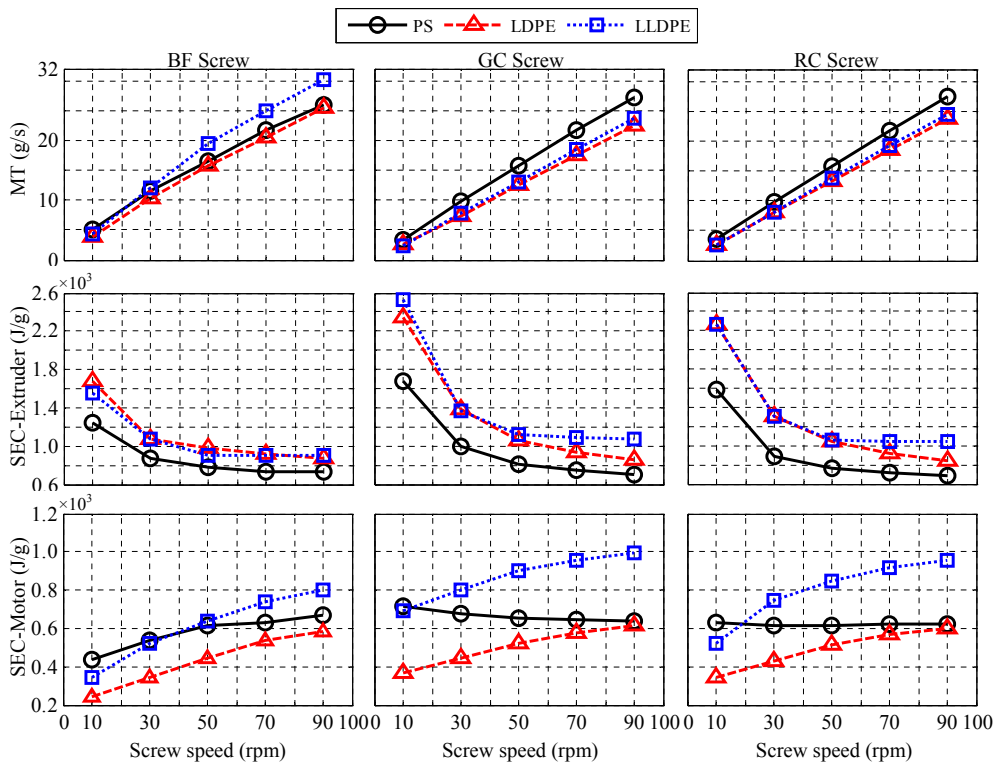

Figure 8: Mass throughput, SEC-Extruder and SEC-Motor under the set temperature condition B

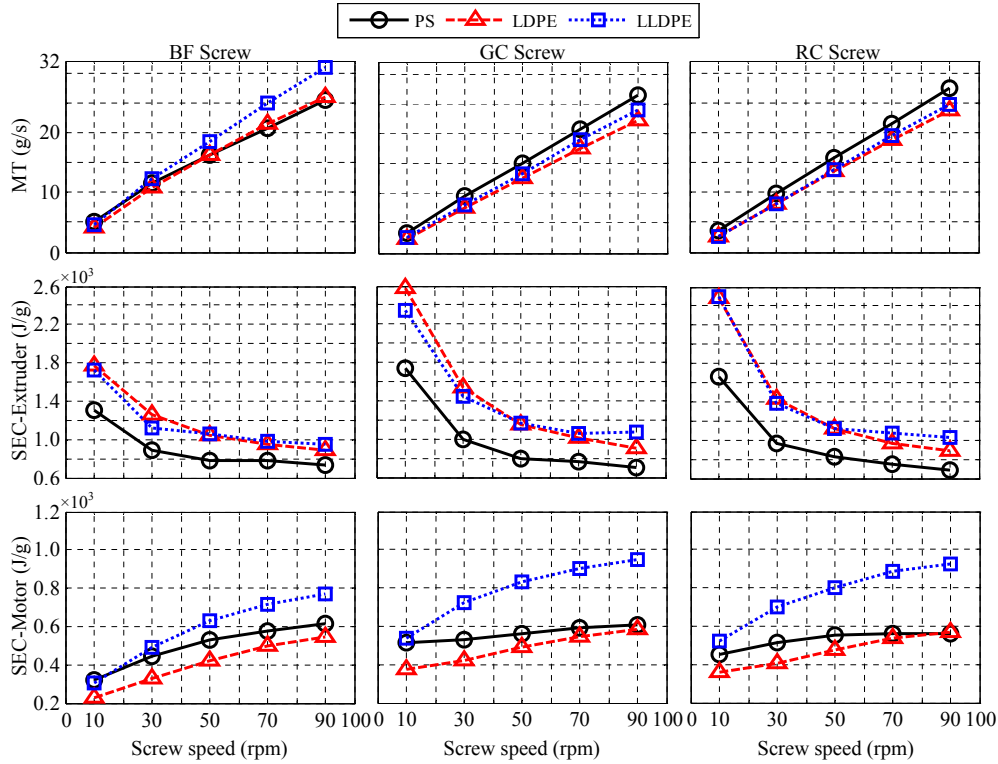

Figure 9: Mass throughput, SEC-Extruder and SEC-Motor under the set temperature condition C

502 which could be due to the high viscous and frictional properties of LLDPE compared to other two materials. Therefore, the higher energy demand and good melting (i.e., not having the low temperature shoulder region) should have some relationship(s) which can be attributed to both viscous and frictional properties of the processing materials as well. In fact, this is a good indication of the material dependency of the extrusion melt thermal quality/efficiency which is another area of further research should be carried out.

511 Ideally, it is required to have flat and consistent temperature profiles across the melt flow for better thermal stability/quality [18, 37, 7, 38, 39]. However, consistency of the melt temperature profiles reduced with screw speed regardless of the screw geometry although the process energy efficiency increases with the screw speed. Therefore, it is clear that the melt thermal quality deteriorates as the process energy efficiency increases. Some previous studies [18] has shown that the variability of the melt temperature across a 38 mm diameter die. As a result, industrial processes are running at conservative rates to achieve the required melt quality by sacrificing the energy efficiency of their plants. Therefore, it is essential to explore ways to run the processes at high speeds while achieving the required melt quality.

525 To further understand the level of process thermal stability the magnitude of melt temperature fluctuations at 70 rpm and 90 rpm at each processing condition were calculated (i.e., the difference between the maximum and minimum) and are shown in Figure 13 (except for the 19 mm die radial position). All the plots are at the same scale and only a half of the melt flow

are shown in each sub-figure as these plots show a symmetrical nature across the melt flow centerline over the selected time.

539 As shown in Figures 4,5 and 6, the difference between the total extruder power and motor power (i.e., power demand of barrel heaters) is always higher with the LDPE. Likewise, the magnitude of thermal fluctuations are higher for the LDPE in the majority of conditions than other two materials as shown in Figures 10, 11, 12 and 13. This implies that there may be a relation with the level of heater power demand and melt thermal fluctuations. According to the observations of this study, it may be argued that the higher the heater power demand the higher the thermal fluctuations. However, this fact also should be further investigated in future for better understanding. Such investigations should help to understand good correlations between process energy demand and thermal stability. Moreover, the highest magnitude of thermal fluctuations across the melt flow exists somewhere around 5 mm from the melt flow centerline with the BF screw for all the materials. For the GC and BF screws, this occurs in-between 8-12 mm from the melt flow centerline depending on the processing conditions. Brown et al. [40] argued that the formation of such highly temperature fluctuating region at the middle of the flow can be attributed to polymer flowing from the melt pool which develops along the screw length. Also, this is an indication of the differences of material mixing capability of different screw geometries. The BF screw has a Maddock mixer at the end and this may help to reduce the level of melt temperature variations across the melt flow via better mixing of molten material. Also, it has dual channels for melt and solid separation which would also help in

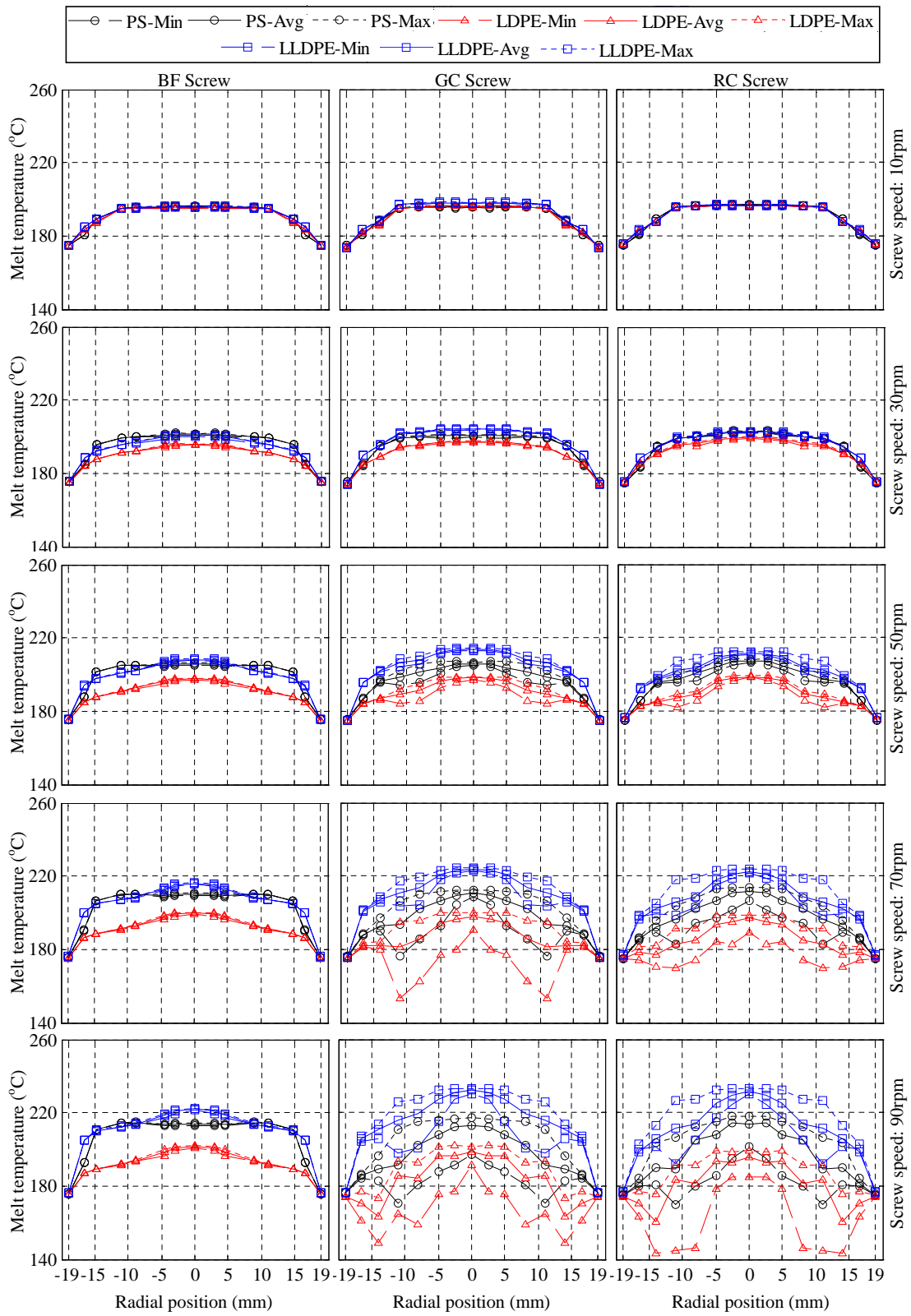

Figure 10: Average melt temperature profile across the melt flow with the magnitude of fluctuations under the set temperature condition A

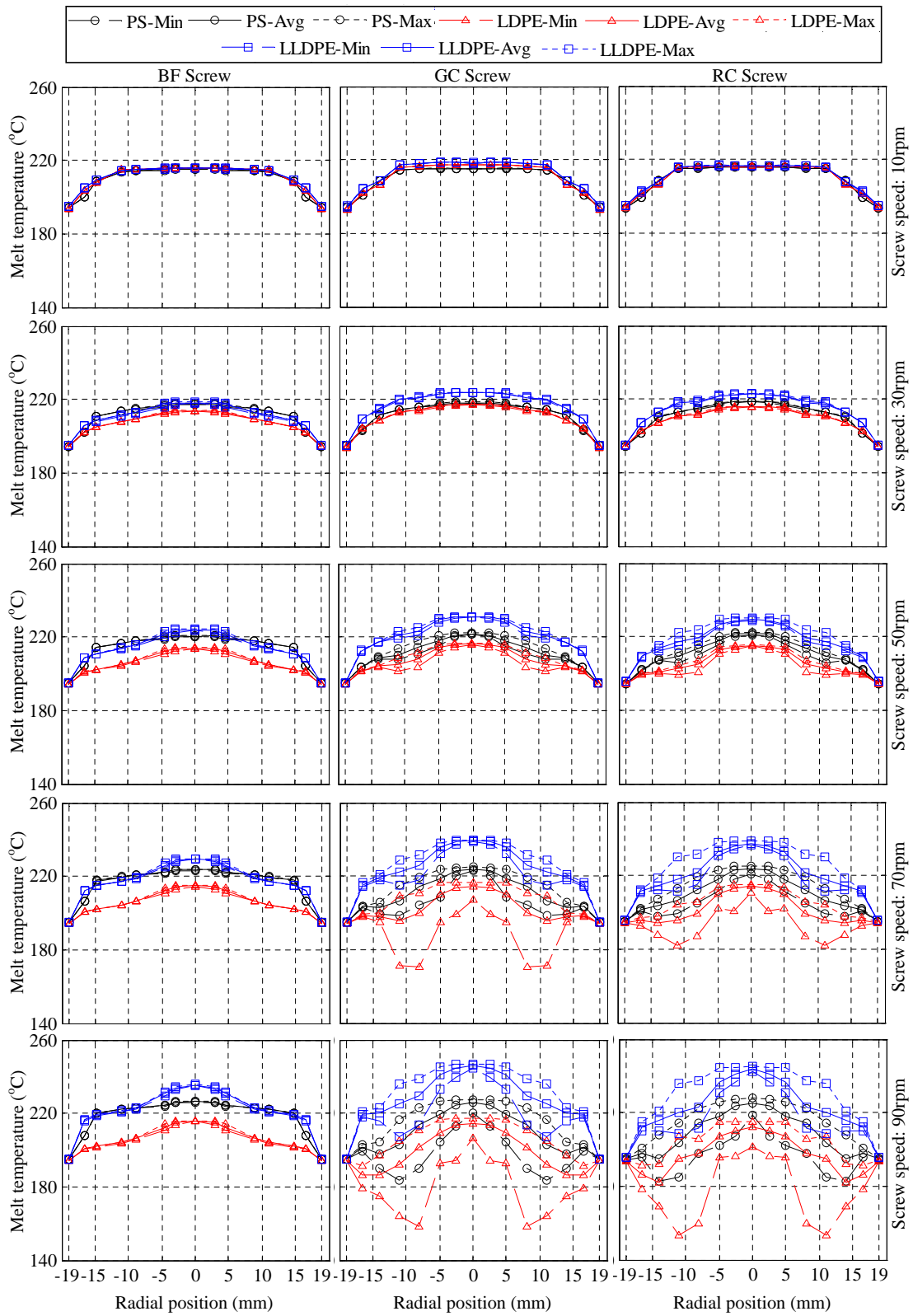

Figure 11: Average melt temperature profile across the melt flow with the magnitude of fluctuations under the set temperature condition B

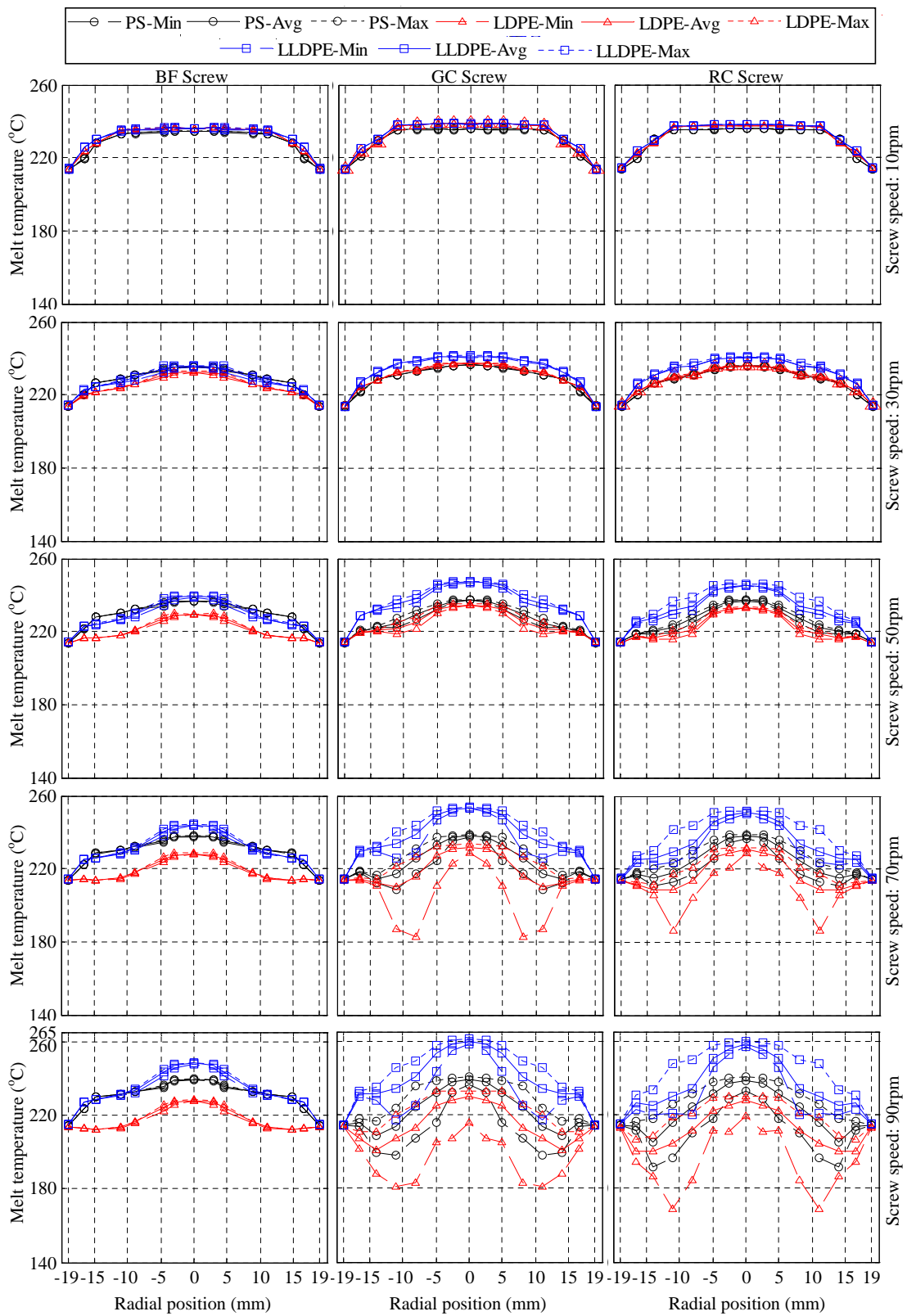

Figure 12: Average melt temperature profile across the melt flow with the magnitude of fluctuations under the set temperature condition C

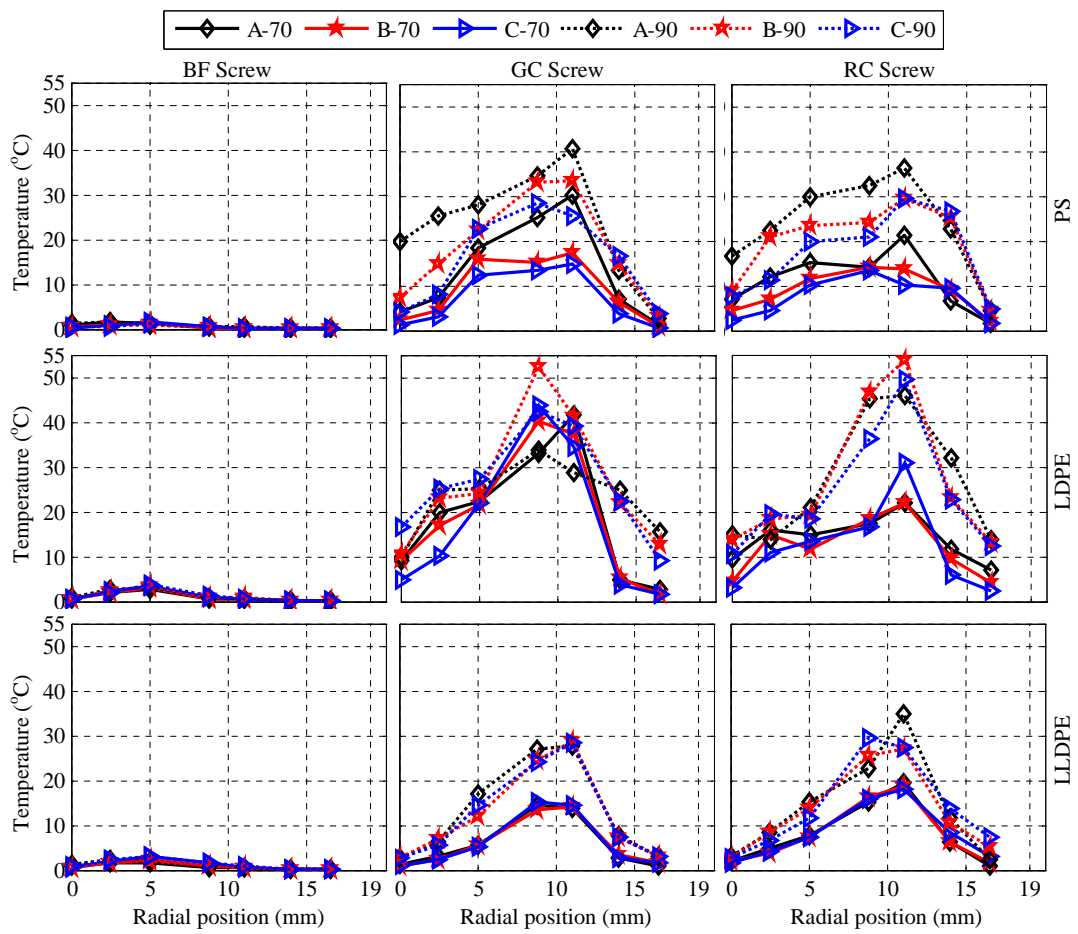

Figure 13: The difference between the maximum and minimum melt temperature at each radial position at 70 and 90rpm

better melting/mixing performance.

4. Conclusions and future work

A comprehensive study on process energy behaviour and melt thermal fluctuations in polymer extrusion were carried out while highlighting a number of areas demanding further research for better understanding. The results are in agreement with the previous findings such as decrease of the extruder specific energy consumption with screw speed and increase of melt thermal fluctuations with the screw speed. Moreover, the findings show that the drive motor specific energy consumption may have increasing or decreasing behaviour with the screw speed although the extruder specific energy consumption reduces with the speed. Furthermore, it was found that the level and magnitude of fluctuations of the extrusion machine's power factor decreases with the screw speed and both of these are dependent upon the polymer type, screw geometry and processing conditions as well. The level of energy demand from the heaters vary with the processing conditions. Also, it is likely that there is relation between the level of energy demand from the heaters and the melt thermal fluctuations, where the higher the energy demand of the heaters the higher the melt thermal fluctuations. However, it is better to conduct further research prior to drawing exact conclusions regarding this particular fact. Also, the results of this study on SEC of the extruder contradict with some previous work on who found that the lower the barrel set temperature the lower the SEC of the extruder. Moreover the radial location of which the highest melt temperature fluctuation is occurred across the melt flow depends particularly on the screw geometry. In general, both energy demand and melt thermal fluctuations are highly varying on the processing conditions. In future, further research is highly recommended to study on the issues such as the extrusion machine's power factor; relation/s between the power demand of the heaters and thermal fluctuations; and motor specific energy consumption.

5. ACKNOWLEDGMENTS

The assistance provided in technical and experimental activities by Javier Vera-Sorroche, Ken Howell, John Wyborn and Roy Dixon is greatly appreciated.

References

- [1] "Plastics applications," Available at: <http://www.bpf.co.uk/plastipedia/applications/Default.aspx> [Online]. Last viewed: 23/06/2015.
- [2] T. Sakai, "Screw extrusion technology past, present and future," *Polimery*, vol. 58, no. 11-12, pp. 847-857, 2013.
- [3] Available at: <http://www.plasticseurope.org/>, last viewed: 10 of August 2012.
- [4] J. Vlachopoulos and D. Strutt, "Overview: Polymer processing," *Materials Science and Technology*, vol. 19, pp. 1161-1169, 2003.
- [5] J. M. Maia, "On-line sensing in extrusion-based processes: past, present and future," *SPE-ANTEC Tech. Papers*, vol. 1, 2012.
- [6] C. Rauwendaal, *Polymer Extrusion*, 4th ed. Hanser, 2001.
- [7] C. Abeykoon, *Polymer Extrusion: A Study on Thermal Monitoring Techniques and Melting Issues*. Lap Lambert Academic Publishing: Verlag, 2012.
- [8] M. J. Stevens and J. A. Covas, *Extruder principles and operation*, 2nd ed. Chapman & Hall, 1995.
- [9] C. Abeykoon, "Single screw extrusion control: A comprehensive review and directions for improvements," *Control Engineering Practice*, vol. 51, pp. 69-80, 2016.
- [10] D. V. Rosato, N. R. Schott, D. V. Rosato, and M. G. Rosato, *Plastics engineering, manufacturing & data handbook: Fundamental and processes*. Kluwer Academic Publishers, 2001, vol. 2.
- [11] G. A. Kruder and R. E. Nunn, "Optimizing energy utilization in extrusion processing," *SPE ANTEC Technical Papers*, pp. 648-652, 1981.
- [12] T. Wildi, *Electrical machines, drives, and power systems*, 4th ed. Prentice Hall, 2000.
- [13] S. J. Chapman, *Electrical machinery fundamentals*. McGraw-Hill, 2005, pp 261-264, 524-527.
- [14] R. A. Sfeir, "Measured savings of DC to AC drive retrofit in plastic extrusion," *Proceedings of the 13th Industrial Energy Technology Conference, New Orleans, USA*, 2008.
- [15] S. Barlow, "Reducing electrical energy costs for extrusion processes," *SPE ANTEC Technical Papers*, pp. 1157-1162, 2009.
- [16] "Extruder line updated with ac vector drives," Available at: <http://www.yaskawa.com/site/dmdrive.nsf>, Last viewed: 10 of August 2012.
- [17] C. Abeykoon, P. J. Martin, A. L. Kelly, and E. C. Brown, "An evaluation of melt temperature sensors for polymer extrusion," *Sensors & Actuators A: physical*, vol. 182, pp. 16-27, 2012.
- [18] C. Abeykoon, "Modelling and control of melt temperature in polymer extrusion," Ph.D. dissertation, Queen's University Belfast, United Kingdom, 2011.
- [19] C. Abeykoon, A. L. Kelly, P. J. Martin, and K. Li, "Dynamic modelling of die melt temperature profile in polymer extrusion," *IEEE Conference on Decision and Control*, vol. 182, pp. 2550-2555, 2013.
- [20] J. V. Sorroche, A. L. Kelly, E. C. Brown, P. D. Coates, N. Karnachi, E. Harkin-Jones, K. Li, and J. Deng, "Thermal optimisation of polymer extrusion using in-process monitoring techniques," *Applied Thermal Engineering*, vol. 53, no. 2, pp. 405-413, 2013.
- [21] N. L. Njobet, "Energy analysis in the extrusion of plastics," Master's thesis, Arcada University of Applied Sciences, 2012.
- [22] K. M. Cantor, "Analyzing extruder energy consumption," *SPE ANTEC Technical Papers*, vol. 2, pp. 1300-1306, 2010.
- [23] C. Abeykoon, M. McAfee, K. Li, P. J. Martin, J. Deng, and A. L. Kelly, "Modelling the effects of operating conditions on motor power consumption in single screw extrusion," *Proceedings of LSMS 2010 and ICSEE 2010*, vol. 6329, no. 2, pp. 9-20, 2010.
- [24] B. Drury, *The control techniques drives and controls handbook*. The Institution of Electrical Engineers, London, 2010, pp 308-312.
- [25] R. Kent, "Energy management in plastics processing - part 10: Motors and drives," Available at: <http://www.tangram.co.uk>, Last viewed: 22 of february 2010.
- [26] A. K. Wood and R. Rasid, "Effect of process variables on melt velocity profiles in extrusion process using single screw plastics extruder," *lastics, Rubber and Composites*, vol. 32, no. 5, pp. 193-198, 2003.
- [27] T. Strauch, F. Gliese, and G. Menges, "Energy usage and conservation in extrusion plants," *Proceedings of Polymer Extrusion III*, London, England, pp. 2-1-2-10, 1985.
- [28] C. Abeykoon, A. L. Kelly, J. Vera-Sorroche, E. C. Brown, P. D. C. J. Deng, K. Li, E. Harkin-Jones, and M. Price, "Process efficiency in polymer extrusion: Correlations between the energy demand and melt thermal stability," *Applied Energy*, vol. 135, pp. 560-571, 2014.
- [29] C. Abeykoon, A. L. Kelly, E. C. Brown, J. Vera-Sorroche, P. D. Coates, K. B. Howell, E. Harkin-Jones, J. Deng, K. Li, and M. Price, "Investigation of the process energy demand in polymer extrusion: A review and an experimental study," *Applied Energy*, vol. 136, pp. 726-737, 2014.
- [30] E. C. Brown, A. L. Kelly, and P. D. Coates, "Melt temperature field measurement in single screw extrusion using thermocouple meshes," *Review of Scientific Instruments*, vol. 75, no. 11, pp. 4742-4748, 2004.
- [31] V. Goodship, *Arburg Practical Guide to Injection Moulding*. Rapra Technology Limited, 2004.
- [32] A. L. Kelly, E. C. Brown, and P. D. Coates, "The effect of screw geometry on melt temperature profile in single screw extrusion," *Polymer Engineering and Science*, vol. 46, no. 12, pp. 1706-1714, 2006.
- [33] T. Osswald and J. P. Hernandez-Ortiz, *Polymer Processing-Modelling and Simulation*. Hanser, 2006, ch 2.

- 685 [34] J. Deng, K. Li, E. Harkin-Jones, M. Price, N. Karnachi, and M. Fei, "Energy
686 consumption analysis for a single screw extruder," *ICSEE 2013*, pp.
687 533–540, 2013.
- 688 [35] H. Yang, Ed., *Polymer Morphology*. Nova Science Publishers Inc. 2012.
- 689 [36] E. C. Brown, A. L. Kelly, and P. D. Coates, "Melt temperature homogeneity
690 in single screw extrusion: effect of material type and screw geometry,"
691 *SPE ANTEC Technical Papers*, pp. 183–187, 2004.
- 692 [37] C. Abeykoon, K. Li, M. McAfee, P. J. Martin, Q. Niu, A. L. Kelly, and
693 J. Deng, "A new model based approach for the prediction and optimi-
694 sation of thermal homogeneity in single screw extrusion," *Control Engi-
695 neering Practice*, vol. 19, no. 8, pp. 862–874, 2011.
- 696 [38] C. Abeykoon, "A novel soft sensor for real-time monitoring of die melt
697 temperature profile in polymer extrusion," *IEEE Transactions on Indus-
698 trial Electronics*, vol. 61, no. 12, pp. 7113–7123, 2014.
- 699 [39] —, "A novel model-based controller for polymer extrusion," *IEEE
700 Transactions on Fuzzy Systems*, vol. 22, no. 6, pp. 1413–1430, 2014.
- 701 [40] E. C. Brown, A. L. Kelly, and P. D. Coates, "Temperature measurement
702 in single screw extrusion: Late melting and thermal instabilities," *SPE
703 ANTEC Tech. Papers*, pp. 77–81, 2003.