

The University of Bradford Institutional Repository

<http://bradscholars.brad.ac.uk>

This work is made available online in accordance with publisher policies. Please refer to the repository record for this item and our Policy Document available from the repository home page for further information.

To see the final version of this work please visit the publisher's website. Available access to the published online version may require a subscription.

Link to publisher's version: <http://dx.doi.org/10.1021/acs.cgd.5b00806>

Citation: Kulkarni C, Wood C, Kelly AL, Gough T, Blagden N, and Paradkar AR (2015) Stoichiometric control of co-crystal formation by solvent free continuous co-crystallization (SFCC). *Crystal Growth & Design*. 15(12): 5648–5651.

Copyright statement: © 2016 ACS. Reproduced in accordance with the publisher's self-archiving policy. This document is the author's version of a Submitted Work that was accepted for publication in *Crystal Growth & Design*. Copyright © American Chemical Society after peer review. To access the final edited and published work see <http://dx.doi.org/10.1021/acs.cgd.5b00806>

STOICHIOMETRIC CONTROL OF COCRYSTAL FORMATION BY SOLVENT FREE
CONTINUOUS COCRYSTALLISATION (SFCC)

*Chaitrali Kulkarni¹, Clive Wood¹, Adrian L. Kelly¹, Tim Gough¹, Nicholas Blagden², Anant
Paradkar^{1*}*

¹Centre for Pharmaceutical Engineering Science, University of Bradford,
Richmond Road, Bradford, BD7 1DP, UK

²School of Pharmacy, University of Lincoln, Brayford Pool, Lincolnshire, Lincoln, LN6 7TS,
UK

* Corresponding Author:

Professor AnantParadkar

Centre for Pharmaceutical Engineering Science,

University of Bradford, Richmond Road, BD7 1DP, UK

Email: A.Paradkar1@bradford.ac.uk

Tel: +44 1274 233900

ABSTRACT

Reproducible control of stoichiometry and difficulties in large scale production have been identified as two of the major challenges to commercial uptake of pharmaceutical co-crystals. The aim of this research was to extend the application of SFCC to control stoichiometry in caffeine: maleic acid co-crystals. Both 1:1 and 2:1 caffeine: maleic acid co-crystals were produced by control of the feedstock composition and process conditions. It was also observed that formation of 2:1 stoichiometry co-crystals involved formation of a 1:1 co-crystal which was subsequently transformed to 2:1 co-crystals. The investigation of stoichiometric transformation revealed that although 1:1 co-crystals could be converted into 2:1 form with addition of excess caffeine, the reverse was not possible in the presence of excess maleic acid. However, conversion from 2:1 into 1:1 was only achieved by melt seeding with the phase pure 1:1 co-crystals. This investigation demonstrates that stoichiometric control can be achieved by SFCC by control of parameters such as extrusion temperature.

Key Words: Co-crystal, stoichiometry, caffeine, maleic acid, SFCC

Co-crystallization is one of the approaches used in the pharmaceutical industry to improve physicochemical properties such as solubility, bioavailability and stability of active pharmaceutical ingredients (APIs)¹. The importance of co-crystals has been reflected by the recent guidelines issued by regulatory agencies for industry concerning the use of cocrystals². Co-crystals existing in different stoichiometries can provide a means to increase the number of potential solid forms for a given molecule, however they can also complicate control of the co-crystallization process and subsequent interconversion. Many research groups are exploring innovative co-crystallisation techniques for stoichiometric control and phase pure co-crystal synthesis^{3,4}. Karki *et al.* reported that grinding can be used to control the formation of stoichiometrically diverse co-crystals by altering the ratio of the reactant mixture⁵. Recently, our group reported SFCC technology based on the application of melt extrusion for the manufacture of cocrystals^{6,7,8}. During this process the drug – co-former mixture is subjected to shear and heating while being conveyed along the barrel length. Extrusion is an effective process for mixing whilst maintaining the stoichiometric ratio of the feed components along its length.

The aim of this study was to explore the application of SFCC to control stoichiometry during co-crystallization using caffeine: maleic acid (**caf:ma**) as a model system. Caffeine is a challenging pharmaceutical compound which exhibits two anhydrous polymorphic forms, one crystalline non-stoichiometric hydrate and one salt phase⁹. Its weak basicity and the possibility of forming heteromeric synthons makes it suitable for co-crystallization. Caffeine shows stoichiometric diversity with maleic acid, forming either 1:1 or 2:1 **caf:ma** co-crystals. Existence of co-crystals in different stoichiometries increases the number of potential solid forms for a given molecule but complicates control of the co-crystallisation process and subsequent inter-conversion. Various co-crystallization techniques used to obtain **caf:ma** co-crystals with 1:1 and 2:1 stoichiometries are summarised in Table 1.

Table 1. Summary of caffeine: maleic acid co-crystallisation studies

Co-crystallisation techniques	Caffeine: Maleic acid co-crystals 1:1	Caffeine: Maleic acid co-crystals 2:1	References
Neat grinding	No	No	Trask <i>et al.</i> , 2009
Liquid assisted grinding	Yes	Yes	Trask <i>et al.</i> , 2009
Solution crystallisation	Yes	No	Leysens <i>et al.</i> , 2012
Ultrasound assisted solution crystallisation	No	Yes	Aher <i>et al.</i> , 2010
Microwave assisted crystallisation	Yes	No	Pagire <i>et al.</i> , 2013
Ultrasound assisted slurry crystallisation	Yes	No	Apshingekar, 2014

Trask *et al.* were the first to perform a thorough crystal engineering study of caffeine with maleic acid using neat and liquid assisted grinding (LAG) methods. This study suggested that 1:1 or 2:1 **caf:ma** co-crystals could be prepared depending on the choice of solvent¹⁰. Methanol favours formation of 2:1 whereas toluene favours 1:1 co-crystals. Guo *et al.* further explored the same system using dry grinding, LAG and solution co-crystallization¹¹. The authors were successful in obtaining 1:1 and 2:1 co-crystals by LAG using acetone for both stoichiometries. Due to the non-congruent solubility behaviour of the two components, an excess of maleic acid (1:7 molar ratio) was required to obtain 1:1 co-crystals in solution crystallisation. Aher *et al.* reported ultrasound assisted solution co-crystallization (USCC) in methanol to yield pure 2:1 **caf:ma** co-crystals¹². However, a significant excess of maleic acid (1:3.5 molar ratio) was required to achieve this. Leysens *et al.* noted the importance of solvent selection during crystallisation of stoichiometrically diverse co-crystal synthesis and showed that formation of **caf:ma** 2:1 co-crystals occurs at high levels of supersaturation⁹.

Pagire *et al.* generated almost phase pure 1:1 and 2:1 **caf:ma** co-crystals using microwave radiation¹³.

Furthermore, it was demonstrated that methanol favours formation of form II of 1:1 **caf:ma** co-crystals in the presence of microwaves. Recently, our group constructed a phase diagram for **caf:ma** co-crystals and studied the effect of ultrasound on it¹⁴. It was observed that 1:1 and 2:1 regions are very narrow, suggesting that it is difficult to obtain phase pure 1:1 and 2:1 co-crystals. Overall, it appeared that solvent selection and kinetics play an important role in formation of **caf:ma** co-crystals. Guo *et al.* reported that the 2:1 co-crystal is an unstable phase compared to the 1:1 stoichiometry at room temperature¹¹. Therefore, it is challenging to obtain phase pure 1:1 and 2:1 **caf:ma** co-crystals, hence the current exploration of controlled stoichiometry by SFCC.

Preliminary screening experiments using DSC (TA instruments Q2000 DSC with RCS90 cooling unit) were performed in order to study **caf:ma** eutectic formation. DSC endotherms are provided in the supporting information. Caffeine showed two endothermic peaks at 156°C and 236°C¹⁵. Maleic acid exhibited a single endothermic melting peak at 143°C followed by degradation at higher temperature indicated by an out of shape recovery of the endothermic peak. DSC thermograms from the physical mixture in 1:1 ratio showed a first endothermic peak at 100°C, significantly lower than the melting point of the either component which may be due to eutectic formation¹⁶. This was followed by a further endothermic peak at 104°C which may be attributed to the melting of 1:1 co-crystal formed during DSC. The physical mixture in 2:1 ratio showed multiple endothermic peaks at 97, 100 and 104°C; again lower than the melting point of either component. The peaks at 97 and 100°C may be due to the eutectic formation in different ratios and the peak at 104°C might be due to the melting of 1:1 co-crystal formed during heating past the eutectic temperature¹⁶. These peaks were followed

by uneven events similar to those with the 1:1 ratio except that an additional peak was observed at 235°C which was attributed to melting of unutilised caffeine in the mixture.

Based on the results of thermal analyses, **caf:ma** acid co-crystallisation experiments were conducted in a twin screw extruder (Pharmalab, ThermoScientific, UK with screw diameter 16 mm and length to diameter ratio 40 : 1) at set temperatures below and above the eutectic temperature at a screw speed of 10 rpm. The screws were configured to produce high shear intensity (described as Configuration C in our previous reports^{6,7,8}). The 1:1 co-crystal batches were processed at set temperatures of T80, T90 and T100, while 2:1 co-crystal batches were processed at set temperatures of T100, T105 and T110; full details of each set temperatures are provided in the supporting information. Powder X-Ray Diffraction (PXRD) measurements made using a Bruker D8 diffractometer (wavelength of X-rays 0.154 nm Cu source, voltage 40 kV, and filament emission 40 mA) were used to characterize the crystalline components.

Caf:ma batches processed below the eutectic point did not show significant co-crystal formation in either 1:1 or 2:1 ratios. The 1:1 mixture was processed at T100 (above the eutectic temperature) resulted in improved conversion levels of (1:1) co-crystals. When a 2:1 mixture was processed at T100 (above the eutectic temperature) peaks corresponding to 2:1 co-crystal ($2\theta = 9, 11.1, 14.2$ and 15.5) and unreacted caffeine ($2\theta=12$) along with traces of 1:1 co-crystal ($2\theta = 11.1, 13.2, 14.2$ and 15.5) were observed. However, processing the same 2:1 mixture at an increased temperature of T110 led to formation of phase pure 2:1 co-crystals. Therefore, all the further co-crystallisation experiments for 2:1 mixture were conducted at T110. Figure 1 shows PXRD patterns of **caf:ma** physical mixture 1:1, **caf:ma** co-crystals 1:1, **caf:ma** physical mixture 2:1 and **caf:ma** co-crystals 2:1. **Caf:ma** 1:1 co-crystals showed an endothermic peak at 104°C whereas **caf:ma** 2:1 co-crystals exhibited an endothermic peak at 118°C as reported by Guo *et al*¹¹.

The issue of stoichiometric control in co-crystals which exists in multiple stoichiometries has been extensively studied recently and the complexity of controlling the purity and interconversion has been discussed. Karki *et al.* compared the co-crystallisation of nicotinamide with 10 dicarboxylic acids from solution, melt and by neat and liquid assisted grinding⁵. These screening experiments suggested that co-crystallisation did not result in the co-crystal composition corresponding to the stoichiometry of the starting material in 50% of cases from solution, 40% of cases from melt and in 25% of cases from neat and liquid assisted grinding. In most cases both stoichiometries could not be obtained using the same technique. Here, SFCC was successfully used to obtain phase pure co-crystals of **caf:ma** in both stoichiometries, through control of composition of the reaction mixture and process temperature. Interestingly a higher processing temperature (T110) was required to obtain 2:1 co-crystals compared to 1:1 co-crystals (T100) even though the eutectic temperatures were noted in a similar range for both ratios.

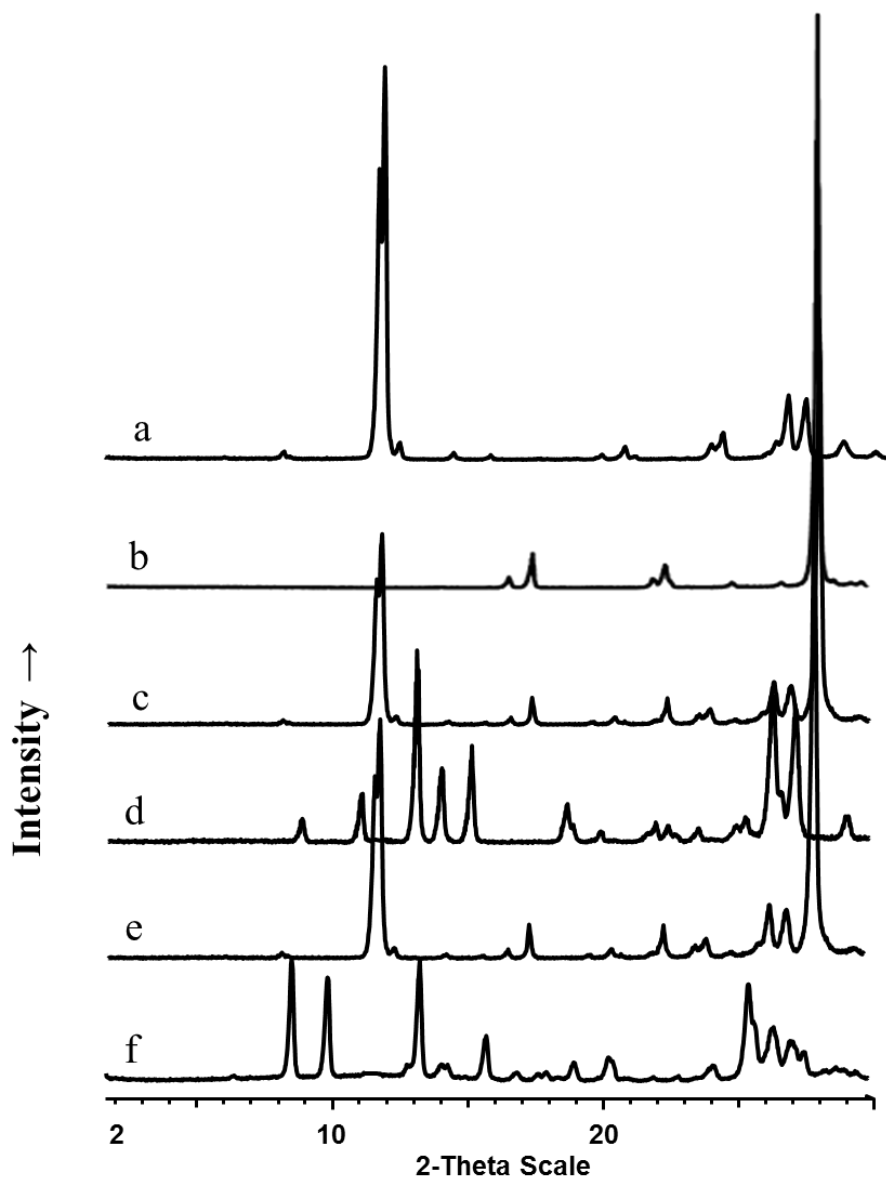

Figure 1. PXR D patterns of (a) caffeine, (b) maleic acid, (c) caffeine: maleic acid physical mixture 1:1, (d) caffeine: maleic acid co-crystals 1:1, (e) caffeine: maleic acid physical mixture 2:1 and (f) caffeine: maleic acid co-crystals 2:1.

As discussed above, extrusion of the 2:1 mixture at T100 resulted in formation of a mixture of 2:1 and 1:1 co-crystals along with caffeine. In order to investigate this further the 2:1 mixture was also extruded at set temperatures of T105 and T110. These experiments showed that at T105 PXR D peaks corresponding to 2:1 co-crystals increased as peaks corresponding to 1:1 co-crystals and caffeine decreased. At temperature set of T110 complete

transformation to 2:1 co-crystal was obtained. This indicates that processing a 2:1 mixture lead to formation of a 1:1 co-crystal which was subsequently transformed to 2:1 co-crystal. Formation of 1:1 co-crystal was favoured when a 2:1 mixture was processed below 104°C, this co-crystal form is stable up to 104°C. As the temperature exceeds 104°C, the 1:1 co-crystal melts and the components are free to form the thermodynamically more stable 2:1 co-crystal. This explains why formation of phase pure 2:1 co-crystals was obtained only after processing at T110. Karki *et al.* also observed formation of 1:1 co-crystals of nicotinamide and suberic acid as an intermediate synthesis during co-crystallisation of 2:1 co-crystal by LAG⁵.

In order to confirm these observations and understand the process of co-crystal formation, a separate experiment was conducted at T110 using the physical mixture in 2:1 ratio. The extrusion process was stopped abruptly and samples were collected at several points along the length of the extruder screw and examined using PXRD. The resulting diffractograms (included in the supporting information) indicated a mixture of a 2:1 blend and 1:1 co-crystals close to the extruder feed section with a gradually increasing proportion of 2:1 co-crystals along the barrel and phase pure 2:1 co-crystals in the terminal zones of the extruder. These results provided further evidence that the formation of 2:1 co-crystal occurred in a stepwise mode, wherein the **caf:ma** 1:1 co-crystals appeared first then successively converted to 2:1 stoichiometry.

Boldyreva *et al.* reported polymorphic transformation of paracetamol is dependent on the increasing and decreasing pressure¹⁷. Therefore, in an attempt to assess the stability of co-crystals produced by SFCC, both stoichiometries were re-extruded at temperature profiles T100 and T110, and the products examined by PXRD. Results indicated that no change in co-

crystal stoichiometry or purity occurred during re-processing, suggesting that both **caf:ma** 1:1 and 2:1 co-crystals were stable at high intensity shear conditions.

An investigation of inter-conversion of stoichiometric form was also performed. **Caf:ma** 1:1 co-crystals obtained by SFCC were mixed with caffeine in an amount equivalent to produce a 2:1 stoichiometry and then extruded. The blend was extruded at different temperature profiles (T90, T100 and T110). Results of subsequent PXRD analyses are provided in the supporting data. Extrusion at T90 showed prominent PXRD peaks at $2\theta=12$ corresponding to excess caffeine along with retention of the peaks corresponding to 1:1 co-crystals. However, processing at T100 showed a significant reduction in peaks corresponding to co-crystal 1:1 and caffeine with a proportional increase in the intensities of the peaks corresponding to co-crystal 2:1. At T110 complete conversion into 2:1 co-crystals was observed. These experiments confirmed the initial observation that formation of 2:1 co-crystals involves formation of 1:1 co-crystals and that SFCC is capable of converting 1:1 stoichiometry into 2:1.

In a similar manner, experiments were conducted on a mixture of 2:1 co-crystals obtained by SFCC, fed into the extruder with excess maleic acid to give a 1:1 molar composition. As 1:1 co-crystals are known to melt at 105°C , an experiment was performed at an extrusion temperature of T120 in addition to T100 and T110. In each of these experiments, no material changes were observed; 2:1 co-crystals along with excess maleic acid were produced as confirmed by PXRD peaks corresponding to 2:1 co-crystals and a peak at $2\theta =28$, corresponding to maleic acid. At T100 and T110 the 2:1 co-crystal does not melt and hence the components are not free for conversion into 1:1 co-crystal. At 120°C (T120) 2:1co-crystals melt and the components are available for conversion into 1:1 co-crystals by utilising the excess maleic acid. However, this conversion was not observed. This observation

indicated that at higher processing temperatures 2:1 appeared to be the favoured stoichiometry.

During solution crystallization, relative stability of **caf:ma** co-crystals is dependent on various factors such as solubility, solvation and nucleation processes. But these factors were found to be greatly reduced during grinding experiments providing more reliable conclusions on the relative stabilities of co-crystals than in solution crystallization⁵. The solvents used in LAG are also reported to favour the formation of particular co-crystal stoichiometries and hence have some degree of influence over the process¹⁰. However, SFCC experiments are completely solvent free and hence independent of the solvent effects and thus can provide valuable insight into the relative stabilities of co-crystals. It was observed during the interconversion experiments that **caf:ma** 1:1 co-crystals are formed as an intermediate during formation of **caf:ma** 2:1. Therefore, 1:1 co-crystal stoichiometry could be converted into **caf:ma** 2:1, whereas the reverse conversion was not possible. These results indicate that the 2:1 stoichiometry obtained from solvent free method is the more stable form of this co-crystal.

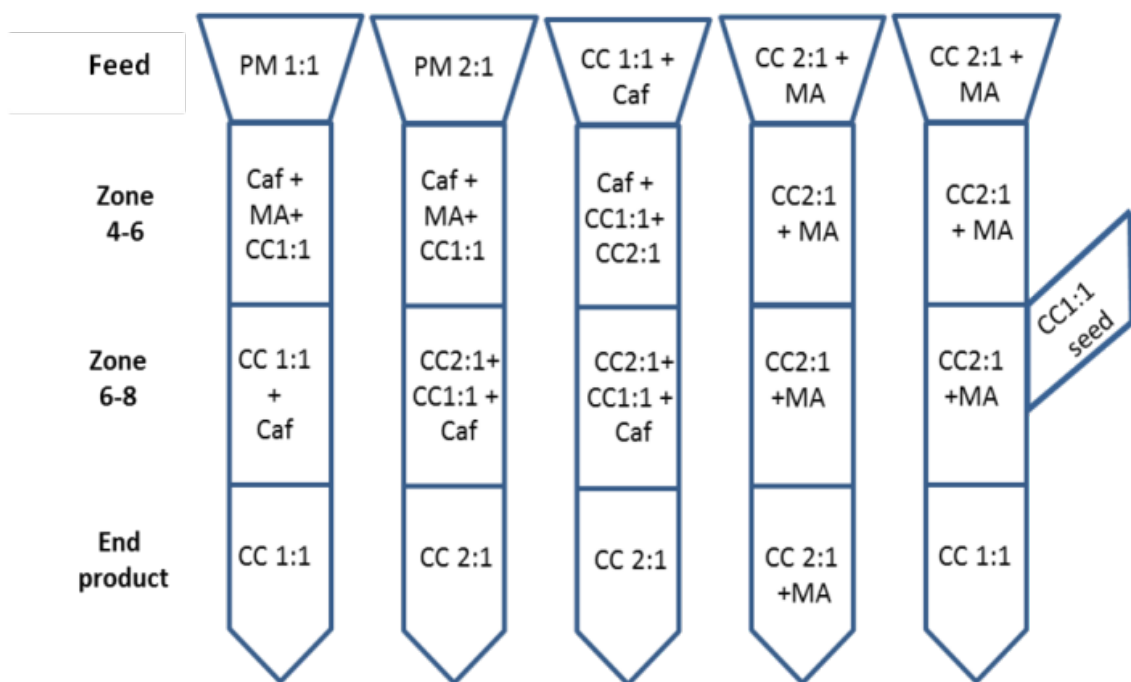

Figure 2. Schematic representation of caffeine: maleic acid co-crystal formation using SFCC

In further experiments, an attempt was made to obtain **caf:ma** 1:1 co-crystals from **caf:ma** 2:1 co-crystals by melt seeding. **Caf:ma** 1:1 co-crystals were mixed with an excess amount of maleic acid. Extrusion was performed at T100, T110 and T120 and 15% **caf:ma** 1:1 co-crystals were added at zone 6 as a seed. Interestingly, all experiments resulted in complete conversion into **caf:ma** 1:1 co-crystals. A schematic representation of this process is shown in figure 2. Similar observations were reported by Orban *et al.* by seeding a melt of pentaerythritoltetrakis- [3-(3, 5-di-tert-butyl-4- hydroxyphenyl) propionate] with a small amount of the crystalline compound¹⁸. This seeding melt approach can be useful in achieving complete conversion to the co-crystals at lower processing temperatures and shear intensities than otherwise required.

CONCLUSION

The application of SFCC has been successfully demonstrated to control stoichiometry of **caf:ma** co-crystals. This solvent-free, high temperature process is capable of yielding phase pure 2:1 **caf:ma** co-crystals. The prepared pure co-crystals were found to be stable during re-extrusion. Conversion of 1:1 co-crystals into 2:1 stoichiometry was readily achieved by SFCC but conversion from 2:1 into 1:1 was only achieved by seeding with the phase pure 1:1 co-crystals. The melt seeding approach is proposed as a useful method to achieve pure co-crystals at low processing temperature and shear intensity.

ASSOCIATED CONTENT

Supporting information includes: PXRD patterns of 2:1 co-crystals from 1:1 caffeine: maleic acid co-crystals processed at different temperature profiles, PXRD patterns of 2:1 co-crystals

with from 1:1 caffeine: maleic acid co-crystals processed at different temperature profiles, PXRD patterns of sample collected from different zone during extrusion of 1:1 co-crystals, PXRD patterns of sample collected from different zone during extrusion of 2:1 co-crystals, DSC thermograms for caffeine, maleic acid, physical mixtures and pure co-crystals, temperature profiles across the different zones of the extruder barrel and co-crystallisation experimental detail showing resultant products.

AUTHOR INFORMATION

Corresponding Author

*E-mail: a.paradkar1@bradford.ac.uk

The authors declare no competing financial interest.

ACKNOWLEDGEMENTS

We wish to thank Prof AshwiniNangia for the helpful discussion. This work was supported by the EPSRC grant no (EP/J003360/1) and UKIREI: UK India Research and Education Initiative (TPR26).

REFERENCES

1. Brittain, H. G. *Cryst. Growth Des.* **2012**, 12, 1046.
2. CDER; Guidance for Industry; Regulatory Classification of Pharmaceutical Co- Crystals, **2011**, 1-4.
3. William, J.; Motherwell, W. D. S.; Andrew, T. *MRS Bull.* **2006**, 31, 875.
4. Schultheiss, N.; Newman, A. *Cryst. Growth Des.* **2009**, 9, 2950.
5. Karki, S.; Friscic, T.; Jones, W. *Cryst. Eng. Comm.* **2009**, 11, 470–481.
6. Dhumal, R.; Kelly, A. L.; York, P.; Coates, P. D.; Paradkar, A. *Pharm. Res.* **2010**, 27, 2725-2733.
7. Paradkar, A.; Kelly, A. L.; Coates, P.D.; York, P. Method and product, WO.2010;013035:A1.
8. Kelly, A. L.; Gough, T.; Dhumal, R.; Halsey, S. A.; Paradkar, A. *Int. J. Pharm.* **2012**, 426, 15-20.
9. Leyssens, T.; Springuel, G.; Montis, R.; Candoni, N.; Veessler, S. *Cryst. Growth Des.* **2011**, 12, 1520-1530.
10. Trask, A., V.; Motherwell, W. D. S.; Jones, W. *Cryst. Growth Des.* **2005**, 5, 1013- 1020.

11. Guo, K.; Sadiq, G.; Seaton, C.; Davey, R.; Yin, Q. *Cryst. Growth Des.* **2010**, 10, 268–273.
12. Aher, S.; Dhumal, R.; Mahadik, K.; Paradkar, A.; York, P. *Eur. J. Pharm. Sci.* **2010**, 41, 597-602.
13. Pagire, S.; Korde, S.; Ambardekar, R.; Deshmukh, S.; Dash, R. C.; Dhumal, R.; Paradkar, A. *Cryst. Eng. Comm.* **2013**, 15, 3705-3710.
14. Apshingekar, P. PhD Thesis, University of Bradford, **2014**.
15. Edwards, H.G.M.; Lawson, E.; De Matas, M.; Shields, L.; York, P. *J. Chem. Soc. Perkin. Trans.* **1997**, 2, 1985-1990.
16. Lu, E.; Rodriguez-Hornedo, N.; Suryanarayanan, R. *Cryst. Eng. Comm.* **2008**, 10, 665–668.
17. Boldyreva, E.; Shakhshneider, T.; Sowa, H.; Uchtmann, H. *J. Therm. Anal. Calorim.* **2002**, 68, 437–452.
18. Orban, I.; Fussenegger, W. Solvent-free crystallization of pentaerythritoltetrakis-[3- (3, 5-di-tert-butyl-4-hydroxyphenyl) propionate] and the novel alpha-crystalline form thereof, US4683326 A, Jul 28, 1987.

For Table of Contents Use Only

STOICHIOMETRIC CONTROL OF COCRYSTAL FORMATION BY SOLVENT FREE CONTINUOUS COCRYSTALLISATION (SFCC)

Chaitrali Kulkarni¹, Clive Wood¹, Adrian L. Kelly¹, Tim Gough¹, Nicholas Blagden², Anant

R. Paradkar^{1}*

¹Centre for Pharmaceutical Engineering Science, University of Bradford,

Richmond Road, Bradford, BD7 1DP, UK

²School of Pharmacy, University of Lincoln, Brayford Pool, Lincolnshire, Lincoln, LN6 7TS,

UK

TOC Graphic:

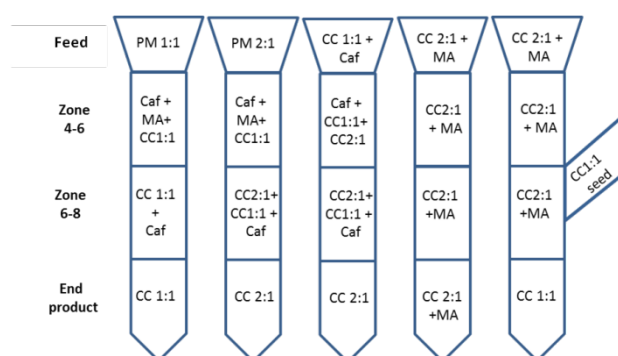

Synopsis:

Reproducible control of stoichiometry and difficulties in large scale production have been identified as two of the major challenges to commercial uptake of pharmaceutical co-crystals. The aim of this research was to extend the application of SFCC to control stoichiometry in caffeine: maleic acid co-crystals. The application of SFCC has been successfully demonstrated to control stoichiometry of the co-crystals.

STOICHIOMETRIC CONTROL OF COCRYSTAL FORMATION BY SOLVENT FREE
CONTINUOUS COCRYSTALLISATION (SFCC)

*Chaitrali Kulkarni¹, Clive Wood¹, Adrian L. Kelly¹, Tim Gough¹, Nicholas Blagden², Anant
R. Paradkar^{1*}*

¹Centre for Pharmaceutical Engineering Science, University of Bradford,
Richmond Road, Bradford, BD7 1DP, UK

²School of Pharmacy, University of Lincoln, Brayford Pool, Lincolnshire, Lincoln, LN6 7TS,
UK

SUPPORTING INFORMATION

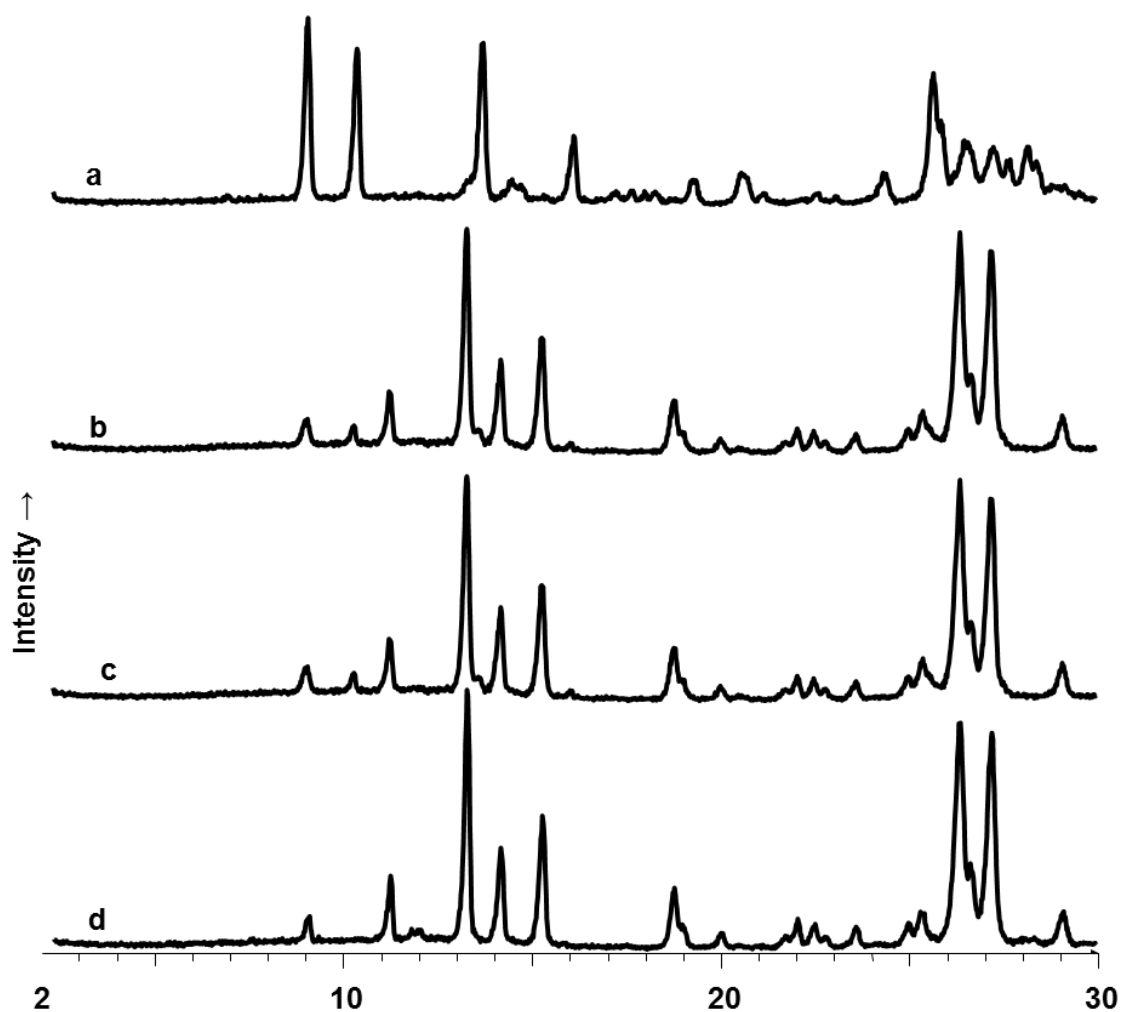

Figure1. PXRD patterns of 2:1 co-crystals from 1:1 caffeine: maleic acid co-crystals processed at different temperature profiles (a) 1:1 co-crystals with maleic acid processed at T110, (b) 1:1 co-crystals with maleic acid processed at T100, (c) 1:1 co-crystals with maleic acid processed at T190 and (d) Pure 1:1 caffeine; maleic acid co-crystals

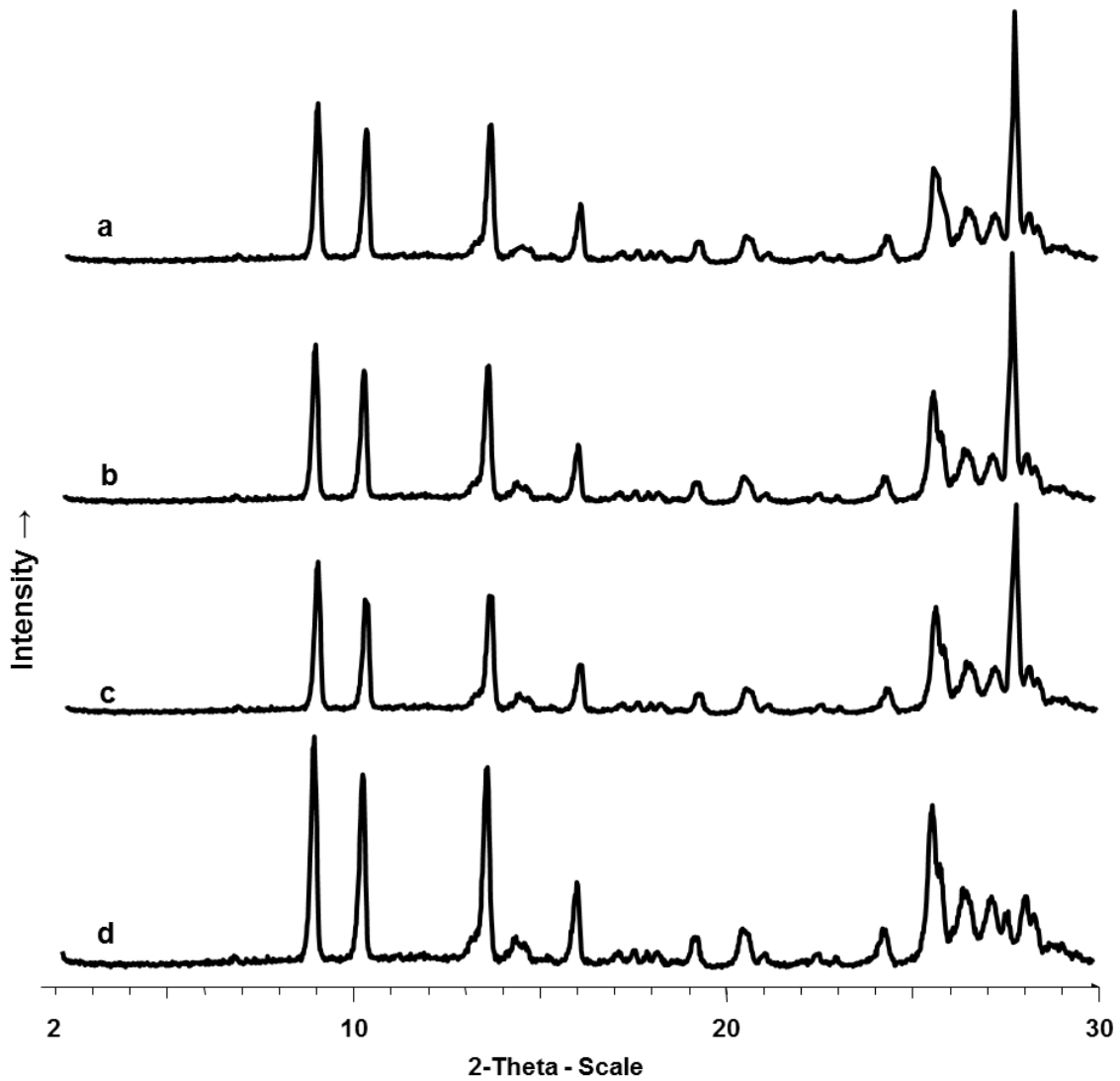

Figure2. PXRD patterns of 2:1 co-crystals with from 1:1 caffeine: maleic acid co-crystals processed at different temperature profiles (a) 2:1 co-crystals with maleic acid processed at T100, (b) 2:1 co-crystals with maleic acid processed at T110, (c) 2:1 co-crystals with maleic acid processed at T120 and (d) Pure 2:1 caffeine: maleic acid co-crystals

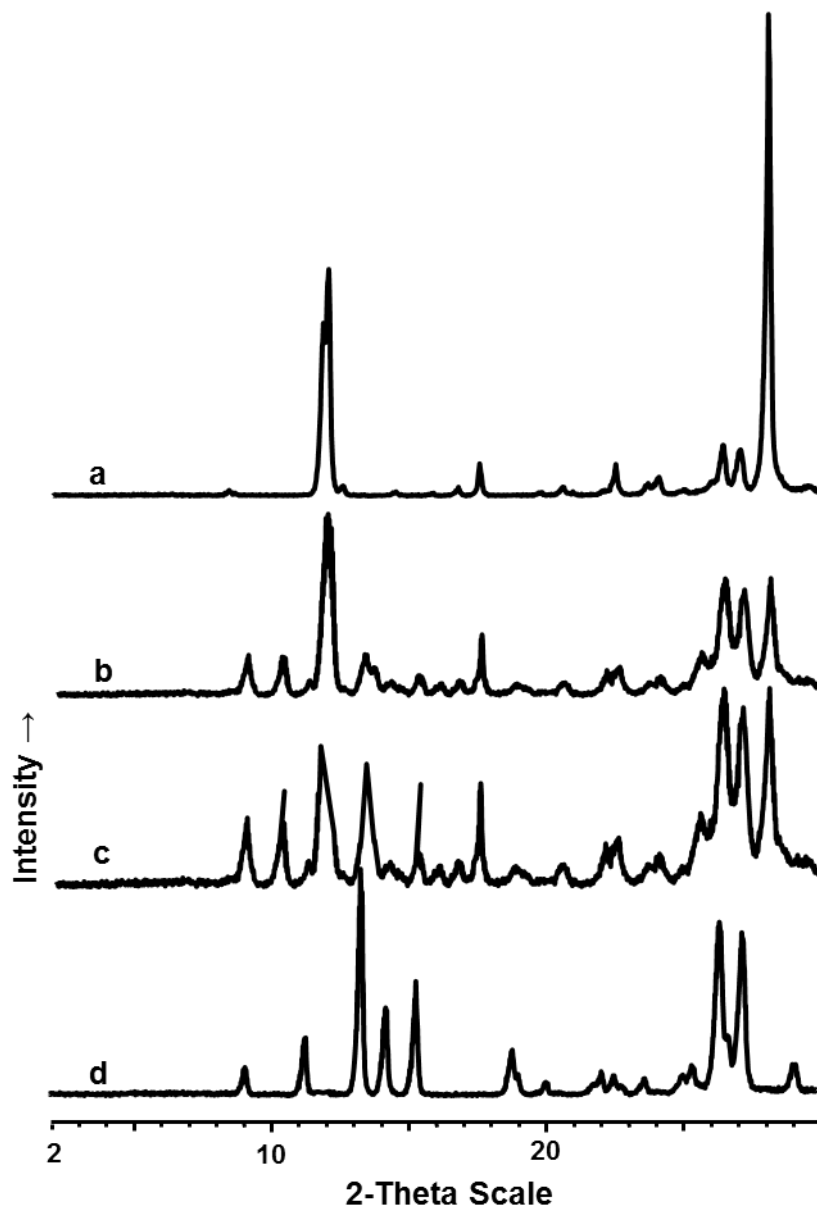

Figure 3. PXRD patterns of sample collected from different zone during extrusion of 1:1 co-crystals (a) sample collected from zones 2-4, (b) sample collected from zones 4-6, (c) sample collected from zones 6-8 and (d) samples collected from zones 8-10

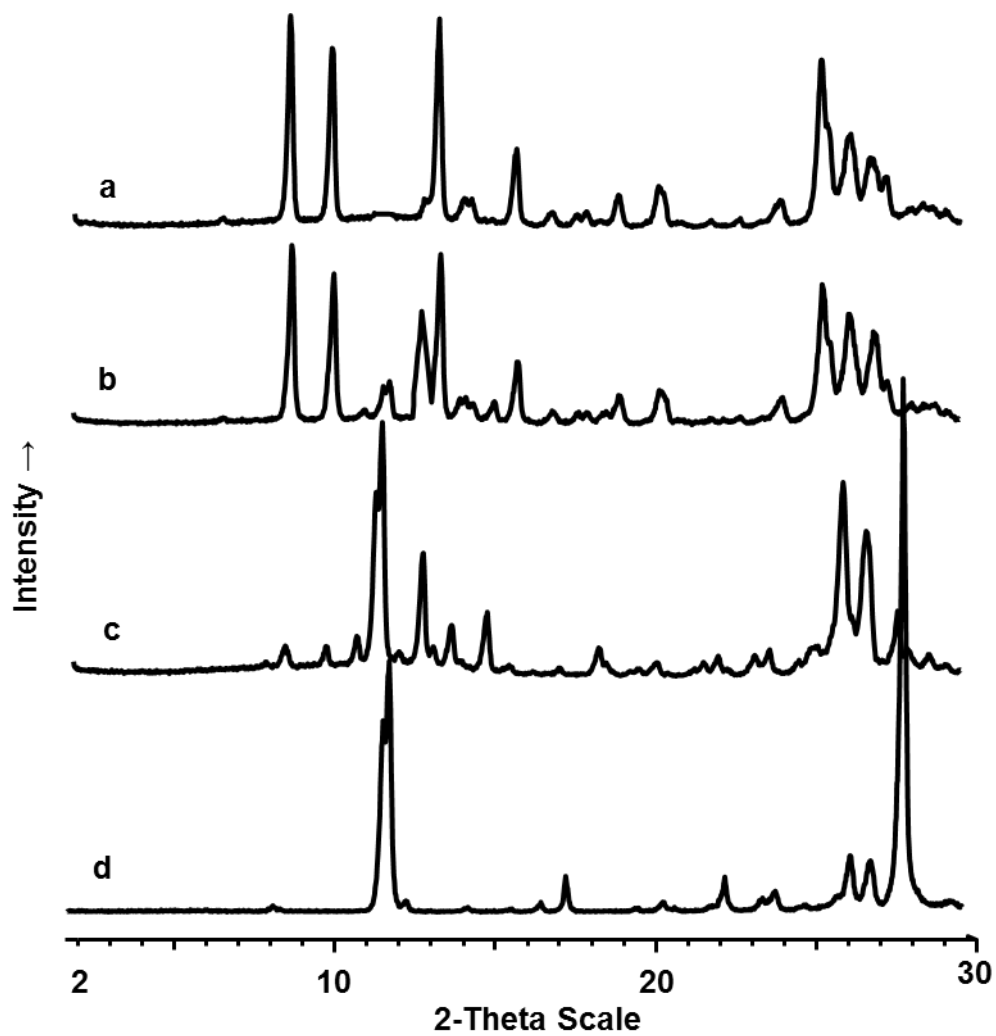

Figure 4. PXRD patterns of sample collected from different zone during extrusion of 2:1 co-crystals (a) samples collected from zones 2-4, (b) samples collected from zones 4-6, (c) samples collected from zones 6-8 and (d) samples collected from zones 8-10

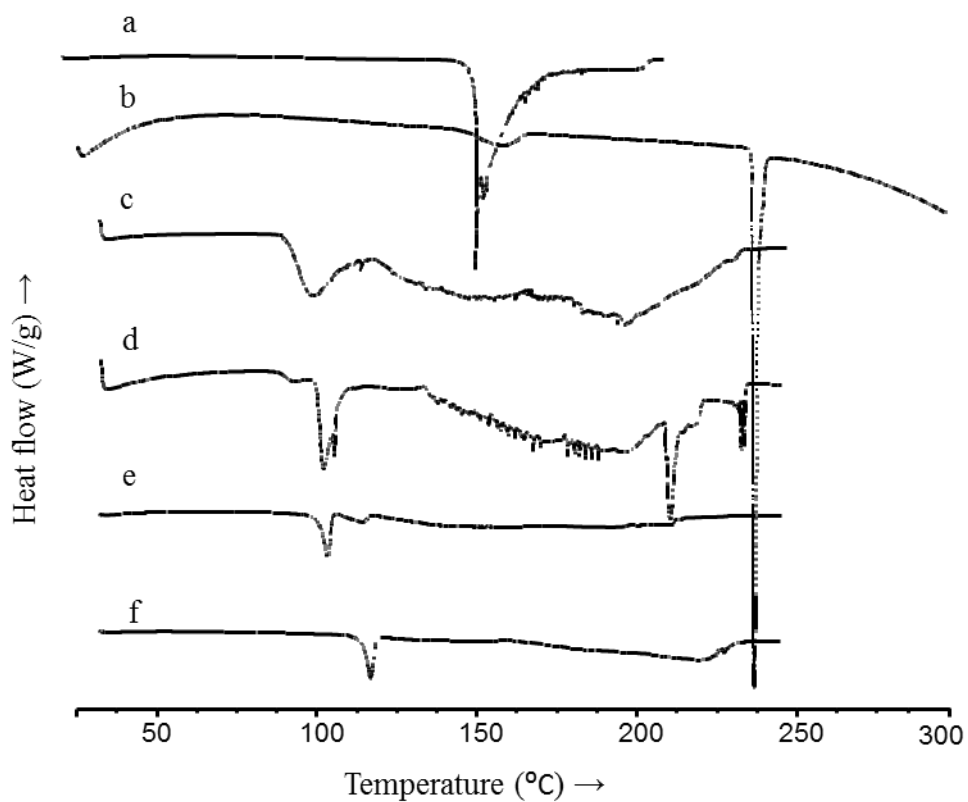

Figure 5. DSC thermograms for (a) maleic acid, (b) anhydrous β -caffeine, (c) physical mixture (1:1), and (d) physical mixture (2:1), (e) caffeine/maleic acid 1:1 co-crystals and (f) caffeine/maleic acid 2:1 co-crystals

Table 1. Temperature profiles across the different zones of the extruder barrel

Code	Zone 10	Zone 9	Zone 8	Zone 7	Zone 6	Zone 5	Zone 4	Zone 3	Zone 2
T90	50	70	90	80	70	55	40	35	25
T100	50	80	100	90	80	55	40	35	25
T105	50	90	105	100	80	55	40	35	25
T110	60	100	110	100	80	60	40	35	25
T120	90	110	120	110	100	90	75	35	25

Table 2: Co-crystallisation experimental detail showing resultant products

Batch code	Gram/batch		Temp. Coding	Screw Speed	Product (major + minor)
	Caffeine	Maleic acid			
Caf:Mal (1:1)	194	116	T100	10	CC
			T90	10	CC + Caffeine
			T80	10	Caffeine + CC
Caf:Mal (2:1)	388	116	T110	10	CC
			T105	10	CC + Caffeine
			T100	10	Caffeine + CC