

The University of Bradford Institutional Repository

<http://bradscholars.brad.ac.uk>

This work is made available online in accordance with publisher policies. Please refer to the repository record for this item and our Policy Document available from the repository home page for further information.

To see the final version of this work please visit the publisher's website. Access to the published online version may require a subscription.

Link to publisher's version: <https://doi.org/10.1016/j.seppur.2018.03.025>

Citation: Aqar DY, Rahmanian N and Mujtaba IM (2018) Feasibility of novel integrated dividing-wall batch reactive distillation processes for the synthesis of methyl decanoate. Separation and Purification Technology. 202: 200-215.

Copyright statement: © 2018 Elsevier B.V. Reproduced in accordance with the publisher's self-archiving policy. This manuscript version is made available under the [CC-BY-NC-ND 4.0 license](#).



Feasibility of Novel Integrated Dividing-Wall Batch Reactive Distillation Processes for the Synthesis of Methyl Decanoate

Dhia Y. Aqar^{1,2}, Nejat Rahmanian¹, Iqbal M. Mujtaba^{1,3}

¹Chemical Engineering Division, University of Bradford, Bradford BD7 1DP, UK

²Ministry of Oil, South Refineries Company, Basra, Iraq

³Corresponding author I.M.Mujtaba@bradford.ac.uk

Abstract

The production of methyl decanoate (MeDC) through esterification of decanoic acid (DeC) with methanol by reactive distillation is operationally challenging and energy-intensive due to the complicated behaviour of the reaction system and the difficulty of retaining the reactants together in the reaction region. Methanol being the lightest component in the mixture can separate itself from the reactant DeC as the distillation proceeds which will cause a massive reduction in the conversion of DeC utilizing either a batch or continuous distillation process. Aiming to overcome this type of the potential problem, novel integrated divided-wall batch reactive distillation configuration (i-DWBD) with recycling from the distillate tank is established in this study and is examined in detail.

This study has clearly demonstrated that the integrated divided-wall batch reactive distillation column (i-DWBD) is superior to the traditional conventional batch distillation (CBD) and both the divided-wall (DWBD), and split reflux divided-wall (sr-DWBD) batch reactive distillation configurations in terms of maximum achievable purity of MeDC and higher conversion of DeC into MeDC. In addition, significant batch time and energy savings are possible when the i-DWBD is operated in multi-reflux mode.

Keywords: Dynamic Modelling, Optimization, Energy Usage, Methyl Decanoate, i-DWBD, Esterification

1. Introduction

Alternative source of fossil fuels (biodiesel) are increasingly becoming an important role in the modern energy revolution due to several factors such as rapid diminishing of crude oil reserves, rising energy demand, rising environmental concerns of global warming, and rising world oil prices. Biodiesel is a renewable and biodegradable fuel composing of methyl esters, which are derived from vegetable oils and animal fats. Methyl decanoate (MeDC), is one

such methyl ester and can be produced from the esterification reaction of decanoic acid (DeC) and methanol (Hernandez et al., 2010; Nguyen and Demirel, 2011; Aqar et al., 2017). Although, the esterification reaction of decanoic acid (DeC) with methanol to produce methyl decanoate (MeDC) using continuous reactive distillation column was studied previously by some investigators (Steinigeweg and Gmehling, 2003; and Machado et al., 2011), a poor performance of product purity and conversion ratio were achieved. Batch reactive distillation operations have been attracted much attention in the last two decades as a promising technology due to its multi-purpose tasks (distillation and reaction) in the chemical industries. Batch distillation processing is more appropriate and flexible than continuous distillation process for small-volume products and high-value-added fine and specialty chemicals, and offers easier start-up and shutdown procedure. Very recently, Aqar et al. (2017) considered the same reaction system using different types of batch distillation columns: integrated conventional (i-CBD) and semi-batch (SBD) distillation columns. The performance of i-CBD and SBD operations was evaluated in terms of total energy consumption for a given product (MeDC) amount and its purity. The i-CBD process was found to offer better performance than the SBD column with the use of excess methanol, while the SBD column was found to outperform the i-CBD process with an equimolar ratio of reactants.

However, the batch distillation and continuous distillation columns are categorised by higher energy demand. To overcome this problem, dividing-wall distillation column (DWC) was used (Petlyuk et al., 1965). The divided-wall column (DWC) is a special column achieved by adding a vertical partition wall inside a one-shell column. Kaibel (1987) patented the divided-wall distillation column shown in Figure 1b, which is thermodynamically equivalent to the thermally coupled Petlyuk distillation system studied by Petlyuk et al. (1965). However, this equality is only valid when there is no heat transfer occurs through the dividing wall. The DWC is a form of implementation of thermally coupled system. Since then, the dividing-wall distillation column technology has been widely used for fluid separations in chemical industries, thereby saving up 30% in total capital costs and reducing utility costs by up to 40% due to preventing remixing influences and increased thermodynamic proficiency (Asprion and Kaibel, 2010; Dejanović et al., 2010; Harmsen, 2010; and Yildirim et al., 2011). Compared with batch and continuous distillation configurations, the dividing-wall column offers a lot of advantages such as high-efficiency, low thermal energy demand, high product qualities, and low equipment cost, as well as low installation space. There is no need to use a total condenser and reboiler for the side column by providing the cooling liquid and the heating vapour-divided streams from the main column to the side column (prefractionator) in

the reactive divided-wall distillation configuration (Figure 1a). The dividing wall (DWC) and Petlyuk systems are examples of the thermally-coupled distillation operation. An important phenomenon of the remixing degree of intermediate component can be occurred in the conventional distillation processes, bring a thermodynamic loss for the entire distillation system as well as wasting a portion of the demanded thermal energy in order to purify the component with the intermediate boiling point temperature from the light component. However, when it is inserted to a mixture in which the heaviest component is the main component, this required more energy. Since the condenser and the reboiler of the prefractionator are omitted through the thermal linking of the two columns, the divided-wall distillation configuration can be employed to reduce the energy expense due to the remixing effect in the prefractionator is minimized in contrast to conventional distillation processes.

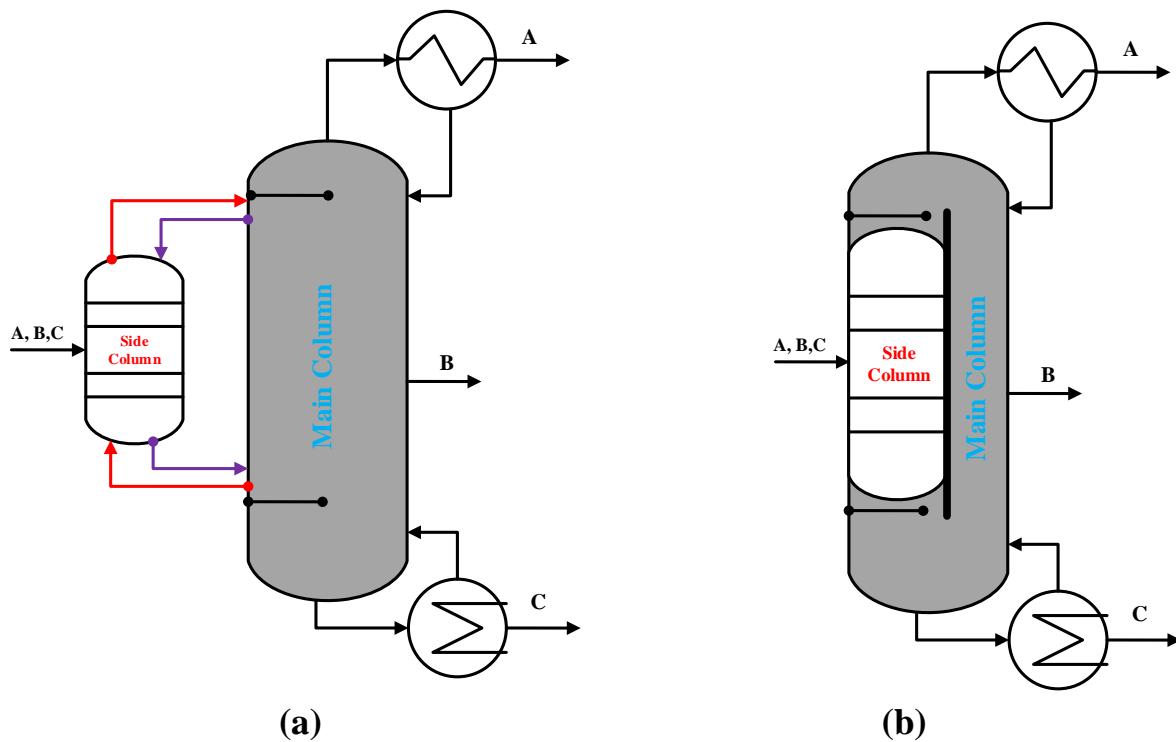

Figure 1: (a) Petlyuk distillation column; (b) Divided-wall distillation column (Safe et al., 2013)

Although the use of dividing wall column has been extensively focused in continuous reactive operations by a number of researchers (Mueller and Kenig, 2007; Hernández et al., 2009; Delgado-Delgado et al., 2012; Cheng et al., 2013; Dai et al., 2015; Suo et al., 2017; Zheng et al., 2017), only very limited works were reported, in the literature, the addition of

dividing-wall into a conventional batch distillation column by some scholars (Safe et al., 2013; Lopez-Saucedo et al., 2016).

Recently, Safe et al. (2013) investigated model reduction and optimization of a dividing-wall batch reactive distillation (DWBD) column for the production of ethyl acetate via esterification of acetic acid with ethanol to obtain higher quality for ethyl acetate and lower batch time. The optimal operation of DWBD mode is evaluated in terms of maximum amount of ethyl acetate produced by optimizing the vapour and liquid split ratios. Their optimization results indicated that the use of DWBD is more powerful operation in terms of maximum purity of acetate and lower operating batch time as compared to the classical CBD column.

In this work, two novel integrated divided-wall batch distillation (i-DWBD) with recycled of methanol rich stream and split reflux divided-wall batch distillation (sr-DWBD) with refluxed of side stream are proposed for the optimal synthesis of MeDC (Figures 2c, 2d). The new column arrangements have two tray distributors (liquid and vapour distributors). The top tray is a liquid distributor, which distributes the liquid flow rate into two columns: main column and prefractionator. While, the bottom tray is the vapour distributor to the right and left-hand sides of the distillation column, respectively. The performances of those column operations are evaluated in terms of minimum energy consumption. A detailed dynamic model based on mass and energy balances is developed and incorporated into the optimization framework. The piecewise-constant policy for the optimization (reflux ratio, liquid, and vapour split ratios (only for DWBD), and refluxed rate of side stream (for sr-DWBD) and methanol recycled rate (for i-DWBD) are employed in the optimization study which are discretized utilizing control vector parameterization (CPV) method (Mujtaba, 2004). The dynamic optimization case is transformed to a nonlinear programming (NLP) problem, which is solved by using the successive quadratic programming (SQP) optimization algorithm within gPROMS Model Builder 5.0 (2017).

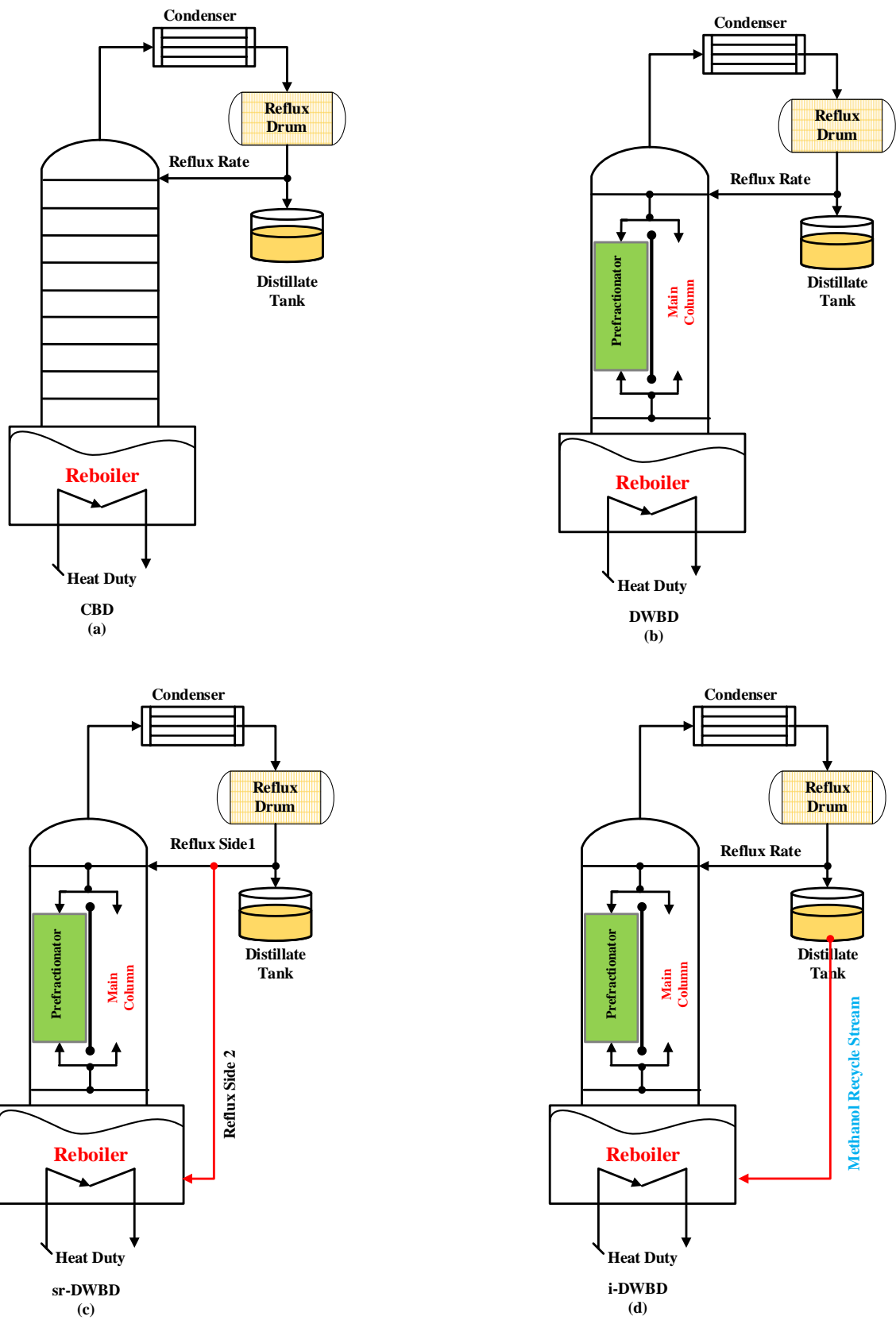

Figure 2: Different types of batch distillation systems: (a) conventional (CBD), (b) divided wall (DWBD), (c) split reflux-divided wall (sr-DWBD), and integrated divided wall columns (i-DWBD).

2. Column configurations and mathematical model

With reference to the different column configurations (such as CBD, DWBD, sr-DWBD, and i-DWBD) as displayed in Figure 2, the process model equations are developed. These mathematical models comprise of a set of differential and algebraic equations (DAEs), which can be decomposed into different equations: unsteady state mass and energy balances with constant molar hold-up on all plates and in the total condenser, equilibrium thermodynamic equations (chemical and physical properties), and other equations. Note, the chemical reaction occurred on the plates, in the still pot and in the total condenser for all column configurations. The plates are calculated from the top down of the staged tower (plate 1 being the overhead condenser and plate N the reboiler drum). The models are based on the following assumptions:

- Negligible plate vapour hold-up
- Adiabatic process (no heat loss)
- Perfect mixing of phases and equilibrium on all column trays
- Fast energy dynamics
- Total condensation with no sub-cooling
- Ideal vapour phase

Note, the model equations for CBD operation can be found in detail in our previous work (Aqar et al., 2016a).

2.1 Dividing wall distillation column (DWBD)

The DWBD system shown in Figure 2(b) is further elaborated in Figure 3 with various model variables shown. It consists of four main sections, namely, condenser, main column, and side column (prefractionator), as well as the reboiler. It can be assumed that the main column and side column of Petlyuk configuration could be integrated into the same vessel, which is named the dividing-wall distillation system (Figure 1b). With a vertical-wall fitted, it is split into the left and right section, and the prefractionator section is located in the left part of DWBD. It has two interconnecting streams between the prefractionator and main column. The divided-wall distillation configuration can be considered thermodynamically as an equivalent to a Petlyuk system since both columns allow the elimination of the condenser and pot drum from the side column (prefractionator), with a consequent saving in energy usage rate. At the top of the liquid distributor plate, there is an interlinking liquid split ratio (r_L) defined as the proportion of the liquid sent back to the prefractionator to the liquid coming down from the first plate of main column. While, the vapour split stream is at the bottom of

vapour distributor plate where interlinking vapour split ratio (r_v) defined as the fraction of the vapour fed to the prefractionator to the total flow rate of vapour coming down from the last plate of main column.

It has been stated previously that the energy usage rate depends strongly on the vapour and liquid split ratios as the key parameters. The energy efficiency of the DWBD operation can be significantly minimised by a small deviation in either the liquid or the vapour split ratio from the optimum conditions. Therefore, it is very important to find the optimum values for those split ratios to minimize the energy consumption rate (Hernandez and Jimenez, 1999; Delgado-Delgado et al., 2012). The divided wall placed inside distillation column can be used to avoid the physical and chemical contacts of left side stream with the right side one. Hence, this can lead to improve process efficiency, and reduce both the operating batch time and energy usage.

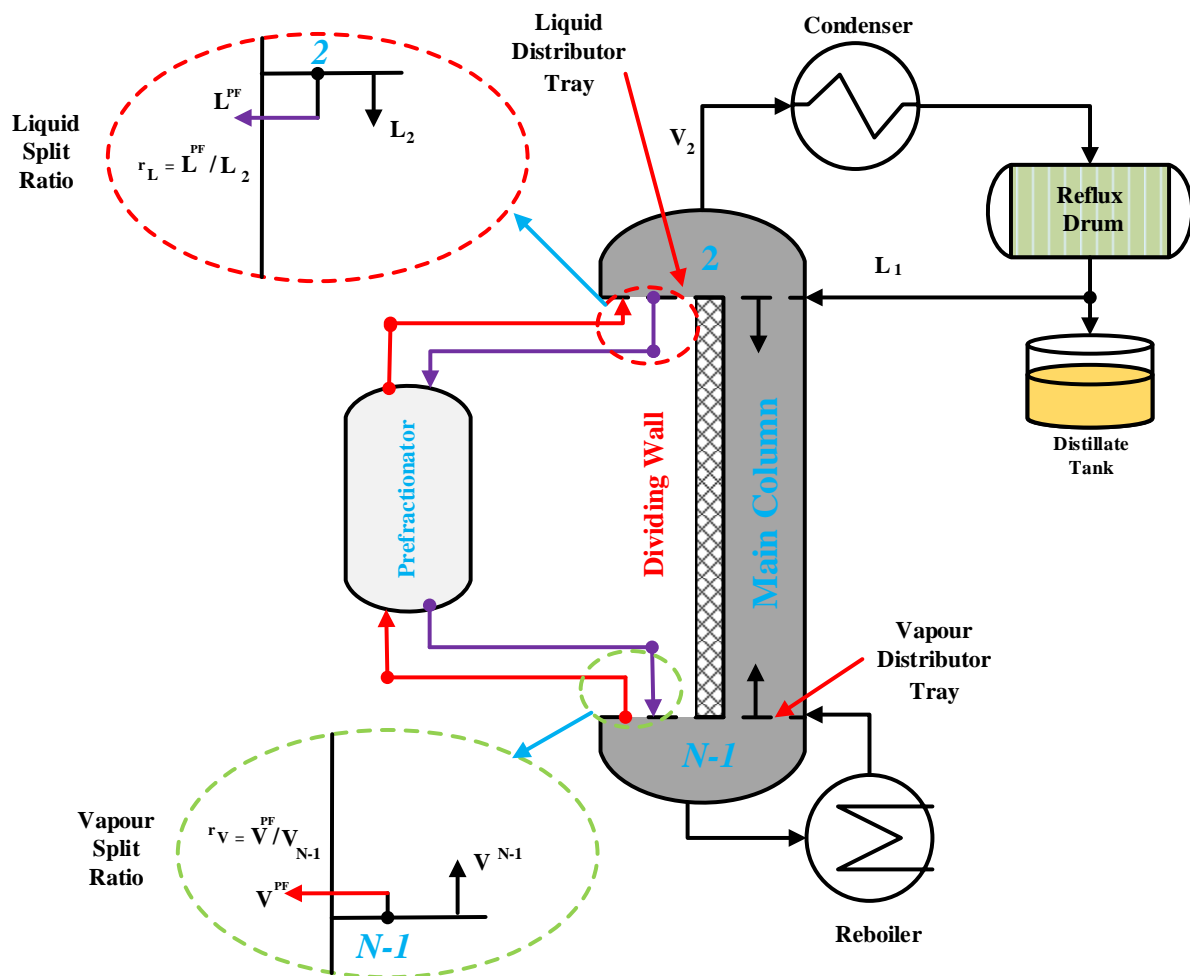

Figure 3: Schematic diagram of the divided wall batch distillation column (DWBD).

The model equations of DWBD are given by the set of Equations (1)-(27), which are similar to those for batch distillation column but include the liquid and vapour split ratios. Note, the new developed model for the DWBD configuration is relied on the models presented by Aqar et al. (2016a), Aqar et al. (2016b), and Safe et al. (2013).

2.1.1. Condenser System and Distillate Tank tray: j = 1

- Distillate Accumulator Total Mass Balance:

$$\frac{dM_a}{dt} = D \quad (1)$$

- Component Mass Balance:

a) Distillate Accumulator:

$$M_a \frac{dx_{ai}}{dt} = D \times (x_{Di} - x_{ai}) \quad (2)$$

b) Condenser Holdup Tank:

$$M_c \frac{dx_{ci}}{dt} = V_2 y_2 - (V_2 + \Delta n_1 M_c) x_{Di} + r_c M_c \quad (3)$$

- Energy Balance:

$$0 = V_2 h_2^V - (V_2 + \Delta n_1 M_c) H_1^L - Q_c \quad (4)$$

2.1.2 Liquid Distributor tray: j = 2

- Total Mass Balance:

$$0 = L_{j-1} - L_j - L^{PF} + V^{PF} + V_{j+1} - V_j + \Delta n_j M_j \quad (5)$$

- Component Balance:

$$M_j \frac{dx_{j,i}}{dt} = L_{j-1} x_{j-1,i} - L_j x_{j,i} - L^{PF} x_{j,i} + V^{PF} y_{j,i}^{PF} + V_{j+1} y_{j+1,i} - V_j y_{j,i} + M_j r_{j,i} \quad (6)$$

- Energy Balance:

$$0 = L_{j-1} H_{j-1}^L - L_j H_j^L - L^{PF} H_j^L + V^{PF} h^{PF} + V_{j+1} h_{j+1} - V_j h_j^V \quad (7)$$

2.1.3 Intermediate plates: j = 3 to N-1

- Total Mass Balance:

$$0 = L_{j-1} - L_j + V_{j+1} - V_j + \Delta n_j M_j \quad (8)$$

- Component Balance:

$$M_j \frac{dx_j}{dt} = L_{j-1} x_{j-1} - L_j x_j + V_{j+1} y_{j+1,i} - V_j y_{j,i} + M_j r_{j,i} \quad (9)$$

- Energy Balance:

$$0 = L_{j-1} H_{j-1}^L - L_j H_j^L + V_{j+1} h_{j+1} - V_j h_j^V \quad (10)$$

2.1.4 Intermediate plates for the prefractionator: j = 3 to N-2

- Total Mass Balance:

$$0 = L_{j-1}^{PF} - L_j^{PF} + V_{j+1}^{PF} - V_j^{PF} + \Delta n_j^{PF} M_j^{PF} \quad (11)$$

- Component Balance:

$$M_j^{PF} \frac{dx_{j,i}^{PF}}{dt} = L_{j-1}^{PF} x_{j-1,i}^{PF} - L_j^{PF} x_{j,i}^{PF} + V_{j+1}^{PF} y_{j+1,i}^{PF} - V_j^{PF} y_{j,i}^{PF} + M_j^{PF} r_{j,i}^{PF} \quad (12)$$

- Energy Balance:

$$0 = L_{j-1}^{PF} H_{j-1}^{PF} - L_j^{PF} H_j^{PF} + V_{j+1}^{PF} h_{j+1}^{PF} - V_j^{PF} h_j^{PF} \quad (13)$$

2.1.5 Vapour Distributor tray: j= N-1

- Total Mass Balance:

$$0 = L_{j-1} - L_j + L^{PF} - V^{PF} + V_{j+1} - V_j + \Delta n_j M_j \quad (14)$$

- Component Balance:

$$M_j \frac{dx_{j,i}}{dt} = L_{j-1} x_{j-1,i} - L_j x_{j,i} + L^{PF} x^{PF} - V^{PF} y_{j,i} + V_{j+1} y_{j+1,i} - V_j y_{j,i} + M_j r_{j,i} \quad (15)$$

- Energy Balance:

$$0 = L_{j-1} H_{j-1}^L - L_j H_j^L + L^{PF} H^{PF} - V^{PF} h_j^V + V_{j+1} h_{j+1}^V - V_j h_j^V \quad (16)$$

- Equilibrium Relationship and Summations:

$$K_{j,i} = \frac{y_{j,i}}{x_{j,i}} \quad \text{where} \quad \sum x_{j,i} = 1 \quad \text{and} \quad \sum y_{j,i} = 1 \quad (17)$$

- Reflux Ratio:

$$R_{DWBD} = \frac{L_1}{V_2} \quad (18)$$

- Liquid Split Ratio:

$$r_L = \frac{L^{PF}}{L_2} \quad (19)$$

- Vapour Split Ratio:

$$r_V = \frac{V^{PF}}{V_{N-1}} \quad (20)$$

- Relations Defining Physical Properties and Chemical Reactions:

$$H_{j,i}^L = H_{j,i}^L(x_{j,i}, T_j, P) \quad (21)$$

$$h_{j,i}^V = h_{j,i}^V(y_{j,i}, T_j, P) \quad (22)$$

$$r_{j,i} = r_{j,i}(k_e, x_{j,i}) \quad (23)$$

$$D = (1 - R)(V_2 + \Delta n_1 M_c) \quad (24)$$

2.1.6 Partial Reboiler: j= N

- Total Mass Balance:

$$\frac{dM_n}{dt} = L_{n-1} - V_n + \Delta n_n M_n \quad (25)$$

- Component Mass Balance:

$$M_n \frac{dx_n}{dt} = L_{n-1}(x_{n-1} - x_n) - V_n (y_n - x_n) + M_n r_n \quad (26)$$

- Energy balance:

$$0 = L_{n-1} (H_{n-1}^L - H_n^L) - V_n (h_n^V - H_n^L) + Q_{\text{Heat}} \quad (27)$$

2.2 The split reflux dividing-wall distillation column (sr-DWBD)

In this column configuration, the reflux coming out of reflux drum is divided to two side streams: reflux side 1 and reflux side 2, where the reflux side 1 goes into the top plate of the column (like DWBD) and the reflux side 2 goes into the reboiler as the process proceeds (Figure 2c). The model of the process sr-DWBD is the most similar to that of the DWBD process discussed in section (2.1) except that the additional terms for the reflux side stream, are to be inserted to model equations in the reboiler section as presented below.

- Reflux Ratio:

$$R_{\text{sr-DWBD}} = \frac{L_1 + S}{V_2} \quad (28)$$

2.2.1 Partial Reboiler: j= N

- Total Mass Balance:

$$\frac{dM_n}{dt} = L_{n-1} - V_n + S + \Delta n_n M_n \quad (29)$$

- Component Mass Balance:

$$M_n \frac{dx_n}{dt} = L_{n-1}(x_{n-1} - x_n) - V_n (y_n - x_n) + S (x_{\text{Di}} - x_n) + M_n r_n \quad (30)$$

- Energy balance:

$$0 = L_{n-1} (H_{n-1}^L - H_n^L) - V_n (h_n^V - H_n^L) + S (H_1^L - H_n^L) + Q_{\text{Heat}} \quad (31)$$

2.3 The Integrated dividing-wall distillation column (i-DWBD)

Figure 2d shows the i-DWBD system with recycled distillate (including a high purity of unreacted methanol) from the distillate tank into the still pot to have further chemical reaction.

Note, the difference between the sr-DWBD and the i-DWBD batch configurations is that, the recycle stream in the sr-DWBD operation contains less methanol and more water, but in the i-DWBD operation more methanol than water. Also, the stream in Figure 2c, is taken from the refluxed liquid to the column section; whereas, the stream in Figure 2d is from the distillate tank. Again, the stream in Figure 2c is the fraction of liquid, which is returned to rectifier as reflux. Note also, the i-DWBD operation model is similar to the DWBD process presented

above in section (2.1) except that the additional terms for the recycled methanol stream inserted into the model equations as revealed below.

2.3.1 Condenser System and Distillate Tank tray: j =1

$$\frac{dM_a}{dt} = D - S_{MeOH} \quad (32)$$

- Component Mass Balance:

a) Distillate Accumulator:

$$M_a \frac{dx_{ai}}{dt} = (D - S_{MeOH}) \times (x_{Di} - x_{ai}) \quad (33)$$

2.3.2 Partial Reboiler: j= N

- Total Mass Balance:

$$\frac{dM_n}{dt} = L_{n-1} - V_n + S_{MeOH} + \Delta n_n M_n \quad (34)$$

- Component Mass Balance:

$$M_n \frac{dx_n}{dt} = L_{n-1}(x_{n-1} - x_n) - V_n (y_n - x_n) + S_{MeOH} (x_{ai} - x_n) + M_n r_n \quad (35)$$

- Energy balance:

$$0 = L_{n-1} (H_{n-1}^L - H_n^L) - V_n (h_n^V - H_n^L) + S_{MeOH} (H^a - H_n^L) + Q_{Heat} \quad (36)$$

- Reflux Ratio:

$$R_{i-DWBD} = \frac{L_1}{V_2} \quad (37)$$

2.4 Kinetics of the reaction and phase equilibria (VLE)

The modified Langmuir-Hinshelwood-Hougen-Watson (LHHW) kinetic model for the production of methyl decanoate (MeDC) was explored previously by Steinigeweg and Gmehling (2003), which is employed in this work. This kinetic model is considered here due to the best representation for the kinetic behaviour of the system by adsorption of water content by the resin catalyst (Amberlyst-15). Methyl decanoate (MeDC) is synthesized by the heterogeneously catalysed esterification of decanoic acid (DeC) and methanol (MeOH) via the reversible reaction scheme together with the normal boiling temperature of each component is accomplished by the following stoichiometric equation:

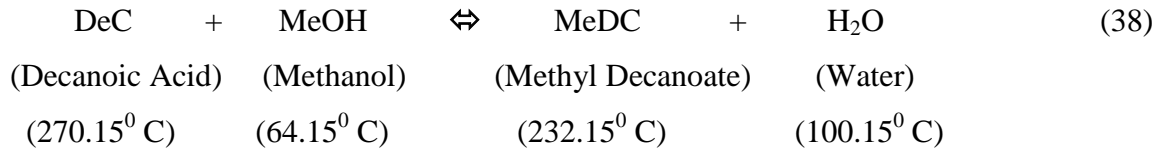

A Langmuir-Hinshelwood-Hougen-Watson (LHHW) activity ($a_i = \gamma_i x_i$) depended on kinetic equatin is employed and has the following form:

$$-r_A = m_{\text{cat}} \left\{ \frac{3.1819 \times 10^6 \exp\left(\frac{-72230}{RT}\right) a_{\text{DeC}} a_{\text{MeOH}}}{(2.766 a_{\text{H}_2\text{O}})^2} - \frac{3.5505 \times 10^5 \exp\left(\frac{-71900}{RT}\right) a_{\text{MeDC}}}{(2.766 a_{\text{H}_2\text{O}})} \right\} \quad (39)$$

Note, the thermodynamic phase equations (VLE) for the reaction system were reported in detail by Aqar et al. (2017).

3. Optimization problem formulation

The optimization problems can be stated as:

Given: The column configurations, the feed mixture, the condenser vapour load,
The product purity, and the quantity of product in the bottom tank.

Determine: The reflux ratio (R) (CBD)

Or, reflux ratio (R), liquid split ratio (r_L), vapor split ratio (r_V) (DWBD)

Or, reflux ratio (R), reflux rate side 2 (S), liquid split (r_L), vapor split ratios (r_V) (sr-DWBD)

Or, reflux ratio (R), MeOH recycle (S_{MeOH}), liquid split (r_L), vapor split ratios (r_V) (i-DWBD)

Minimize: The total energy consumption

Subject to: Model equations, Process constraints

The optimization problem (OP) for the column configurations (Figure 2) is represented mathematically as:

$$\begin{array}{ll}
\text{OP} & \text{Min } Q_{\text{tot}} \\
& R(t) \quad \text{(For CBD Column)} \\
& \text{Or} \\
& R(t), r_L(t), r_V(t) \quad \text{(For DWBD Column)} \\
& \text{Or} \\
& R(t), S(t), r_L(t), r_V(t) \quad \text{(For sr-DWBD Column)} \\
& \text{Or} \\
& R(t), S_{\text{MeOH}}(t), r_L(t), r_V(t) \quad \text{(For i-DWBD Column)}
\end{array} \quad (40)$$

Subject to :

$$f(t, \dot{x}(t), x(t), u(t), v) = 0; \quad [t_0 \quad t_p] \quad (\text{Process model, equality constraint})$$

$$P_{\text{MeDC}} = P_{\text{MeDC}}^* \pm \varepsilon_p \quad (\text{Inequality Constraints})$$

$$x_{\text{MeDC}} = x_{\text{MeDC}}^* \pm \varepsilon_x \quad (\text{Inequality Constraints})$$

$$\text{Linear bound on } R(t), S(t), S_{\text{MeOH}}(t), r_L, \text{ and } r_V \quad (\text{Inequality constraints})$$

$f(t, \dot{x}(t), x(t), u(t), v) = 0$, represents the dynamic process model presented in section 2, where t is the independent variable (batch time), $x(t)$ is the system of all differential and algebraic variables, $\dot{x}(t)$ denotes the derivative of differential variables with respect to operating batch time, $u(t)$ represents the control variables, and v is the set of fixed parameters (the design variables). $[t_0 \quad t_p]$ is the time interval of interest, and the function f : is assumed to be continuously differentiable with respect to all its arguments (Morrison, 1984; Ekpo and Mujtaba, 2007). P_{MeDC} and x_{MeDC} are the amount of product and quality of MeDC at final batch time (t_p) in the still pot, ($*$ denotes that the P_{MeDC} and x_{MeDC} are specified). $R(t)$ is the time dependent reflux ratio, $S(t)$ is the reflux rate stream profile (for the sr-DWBD column), $S_{\text{MeOH}}(t)$ is the methanol recycle rate profile (for i-DWBD column), and $r_L(t)$ and $r_V(t)$ are the ratios of liquid split and vapour split into the divided-wall process (for the DWBD, sr-DWBD and i-DWBD columns), which are optimized into the optimization study as major design parameters. ε_p , and ε_x are very small positive numbers of the order of 10^{-3} . The differential and algebraic equations (DAEs) (see section 2) performing as equality constraints to the optimization problem, which describe the process models. Note, the total energy demand for the different column schemes is computed utilizing the following equation:

$$Q_{\text{tot}} = \int_0^{t_p} Q_{\text{Heat}} dt \quad (41)$$

4. Results and Discussion

4.1. The Performance of Classical CBD Column

The production of methyl decanoate is considered in a CBD with a total of 10 stages (including both condenser and still pot) with constant vapour condenser load of 2.5 kmol/hr. The total fresh feed charged to the pot drum is 5 kmol with the following feed composition <Decanoic Acid, Methanol, Methyl Decanoate, Water> is <0.5, 0.5, 0.0, 0.0>. The column stages are computed from the top to bottom, indicating total condenser as 1st stage and still pot as 10th stage. Four percent of the initial feed charge is considered as the total column

hold-up (half of this hold-up is placed in the overhead condenser and the other half is equally divided on the trays).

At the beginning of process, the compositions of condenser and column plates are initialized to the feed composition. In the start-up period, the reactive batch column starts running under total reflux mode for a certain period until it attains a steady-state condition and then the column composition profiles are consequently established. The production phase commences from this point (designated as $t = 0$) for all cases onward.

The performance of the CBD system is evaluated in terms of minimum energy required for different MeDC purities but for a given amount of bottom product, which is 2.5 kmol. The optimum operating policy for CBD column is displayed in Table 1, comprising the optimal reflux ratio, final operation time, minimum energy demand, and conversion level of DeC into MeDC for a range of product constraints (0.535 to 0.573) at equimolar ratio in the feed.

The results of Table 1 demonstrated that all reflux ratio, final batch time, and energy consumption, as well as the maximum achievable conversion of DeC increase progressively with increasing the purity of the product. Note, the internal reflux ratio ($R_{\text{CBD}} = \frac{L_1}{V_2}$) is employed in this work, which bounds between 0 (= zero reflux) and 1 (= total reflux).

As seen, the CBD column operates at high reflux mode and more batch time to accomplish the maximum MeDC purity of 0.572 mole fraction as compared to others (Table 1). It can be indicated from Table 1 that it is difficult to achieve a higher DeC conversion rate and MeDC at a purity > 0.572 mole fraction using a conventional batch distillation operation. This is because methanol as reactant reaction is removed from DeC in the bottom tank quickly (due to large difference in boiling points of reactants) and the backward reaction being active.

Table 1. Optimal operation results for the MeDC production for CBD column at equimolar ratio.

Product Purity, x_{MeDC}^*	Optimal Reflux Ratio, R	Batch time, t_p , hr	Energy Usage, Q_{tot} , GJ	Conversion of DeC (%)
0.535	0.839	5.71	0.545	57.53
0.545	0.866	6.85	0.654	58.52
0.555	0.891	8.48	0.809	59.50
0.572	0.942	15.87	1.522	61.20
0.573	--- ^a	--- ^a	--- ^a	--- ^a

^aNot achievable

The optimization results, including the reboiler and accumulator tank mole fractions profiles at the end of batch operation for different product concentrations are summarized in Table 2. Note, methyl decanoate (the main product) is in the pot drum and a more unconverted DeC, whereas, the distillate accumulator comprises only methanol and water. It is noted that the compositions of both DeC and MeDC are small in the distillate receiver due to their higher boiling point temperatures.

Table 2. The bottom and distillate composition profiles at several purities of MeDC using CBD column

Purity of MeDC	x_{DeC}	x_{MeOH}	x_{H2O}	* x_{DeC}	* x_{MeOH}	* x_{MeDC}	* x_{H2O}
0.535	0.424	2.69E-5	0.041	2.17E-6	0.540	4.34E-9	0.460
0.545	0.414	2.66E-5	0.040	2.14E-6	0.529	4.28E-9	0.471
0.555	0.405	2.64E-5	0.040	2.28E-6	0.518	4.56E-9	0.482
0.572	0.388	2.41E-5	0.040	2.14E-6	0.499	4.27E-9	0.501

*The composition in the distillate accumulator (molefraction).

4.2. Divided-wall batch distillation operation (DWBD)

Having studied the classical CBD column in section 4.1, it will now be interesting to investigate efficiency of divided-wall reactive distillation for the reaction system concerned in terms of minimum energy consumption. The developed divided-wall distillation column (DWBD) configuration for batch distillation processing by Safe et al. (2013), which is employed in this work to investigate whether can improve energetic and economic performance, and decrease energy consumption. As shown in Figure 3, the intermediate trays of the classical batch distillation column are vertically divided by a metal wall into two separate parts, namely the main column and prefractionator section. Note, the metal wall as a barrier wall uses to avoid contacting of both liquid and vapour streams in the right side with left side stream. Note, the operating conditions and column specifications of the DWBD process and the hold-up distribution policy are similar to those employed in the CBD process (see section 4.1) with a difference that a metal wall divided the column into two vertical sections through stages 3 to 8.

Table 3 summarizes optimal reflux ratio, liquid split ratio, and vapour split ratio profiles, minimum operating time, and total energy usage, as well as maximum conversion rate of DeC (%) for different bottom product qualities. For all cases, the amount of MeDC in the reboiler drum is kept constant as 2.5 kmol (same as CBD column). It can be noticed that as

the quality of MeDC increases, values of reflux ratio, batch time, and thermal energy consumption increase together with the conversion of DeC. It can be observed from Table 3 that the novel DWBD system provides more operational flexibilities and economic perspectives and significant savings in energy use than its classical CBD mode.

A comparative analysis of DWBD operation and its CBD counterpart is explored in terms of two performance indicators, namely batch time, and thermal energy reductions. It is noticed that the proposed DWBD configuration can secure a 38.80%, and 38.89% savings in production batch time and energy required at MeDC purity of 0.572 mole fraction compared to those obtained by utilizing the CBD process (Table 1). Moreover, it can be seen that clearly the DWBD system produced a higher purity of MeDC (0.605 mole fraction), converted more DeC (64.50%) compared to those obtained by CBD column (Table 1). It was found that the optimal ratios of liquid (r_L) and vapour (r_V) splitting at the top and bottom for the left section of the portion-wall, respectively, have significant effect on the overall performance to achieve the product constraints in terms of maximum product purity and a higher conversion rate of acid compared to the traditional CBD process. However, it was impossible to obtain higher product concentration beyond 0.606 mole fraction of MeDC and conversion of DeC due to a rapid removal of methanol from the bottom tank to the distillate receiver (see Table 4). Table 4 lists the bottom and distillate compositions profiles for different product purities at the end of processing time. As before, more methanol and water are gathered in the distillate receiver, while, it is mainly unreacted DeC and MeDC in the reboiler tank. Note, the amount of accumulator tank was found to be 2.3 kmol for all cases.

Table 3. Optimal operation results for the MeDC production for DWBD column at equimolar ratio.

Product Purity, x_{MeDC}^*	Optimal Reflux Ratio, R	Liquid Split Ratio, r_L	Vapor Split Ratio, r_V	Batch time, t_p , hr	Energy Usage, Q_{tot} , GJ	Conversion of DeC (%)
0.572	0.905	0.84	30.05	9.71	0.930	61.21
0.585	0.914	0.22	41.22	10.71	1.029	62.51
0.595	0.939	0.30	85.92	15.00	1.444	63.52
0.605	0.966	0.18	51.96	27.28	2.642	64.50
0.606	--- ^a	--- ^a	--- ^a	--- ^a	--- ^a	--- ^a

^aNot Achievable

Table 4. The bottom and distillate composition profiles at several purities of MeDC using DWBD column

Purity of MeDC	x_{DeC}	x_{MeOH}	x_{H2O}	x_{DeC}^*	x_{MeOH}^*	x_{MeDC}^*	x_{H2O}^*
----------------	-----------	------------	-----------	-------------	--------------	--------------	-------------

0.572	0.387	2.72E-5	0.040	2.13E-6	0.499	4.27E-9	0.501
0.585	0.374	2.85E-5	0.041	2.17E-6	0.485	4.33E-9	0.515
0.595	0.364	2.77E-5	0.040	2.20E-6	0.474	4.41E-9	0.526
0.605	0.355	2.58E-5	0.040	2.00E-6	0.462	4.00E-9	0.538

*The composition in the distillate accumulator (molefraction).

The molar concentration profiles of the CBD and the DWBD systems at the bottom product purity of 0.572 (mole fraction) are presented in Figures 4 and 5, respectively. It can be seen that there are remixing effects the intermediate component H₂O with MeOH (the lightest component) occurred on top of CBD at the final batch time of 15.87 hr, which can make the separation more challenging and need much more energy about 1.522 GJ. However, the remixing phenomenon in the concentration of H₂O with MeOH can be still observed at the top of DWBD column but required a lower batch time of 9.71 hr in the contrast of CBD process. Therefore, the total energy consumption for DWBD configuration is reduced to 0.930 GJ, which saves 38.89% at MeDC concentration of 0.572 mole fraction.

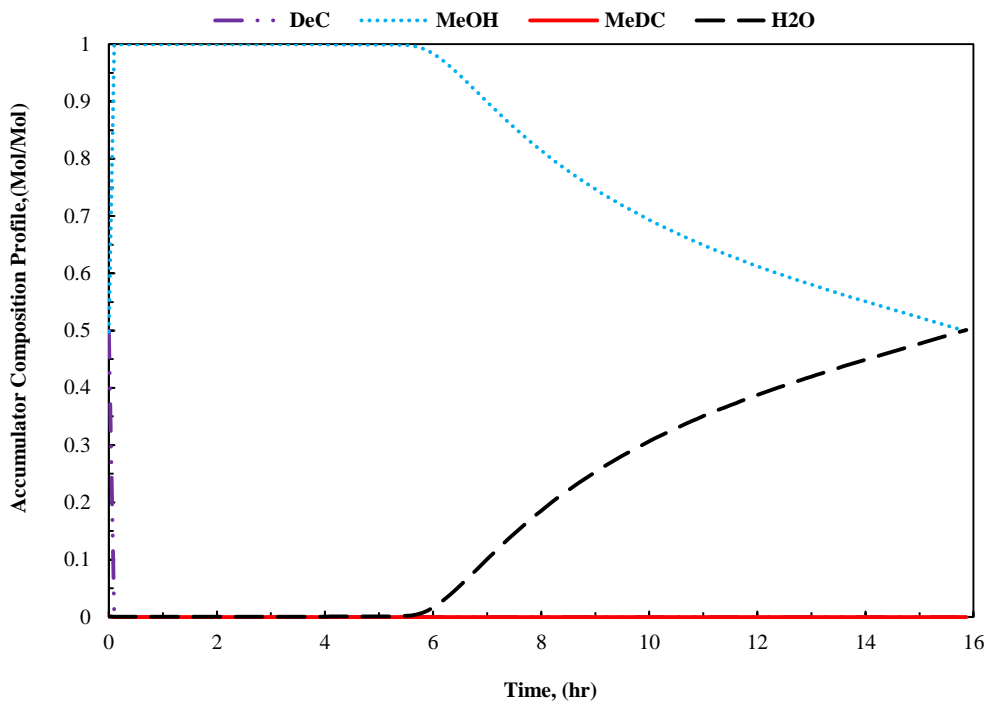

Figure 4: Accumulator composition profiles of CBD column ($x_{\text{MeDC}}^* = 0.572$).

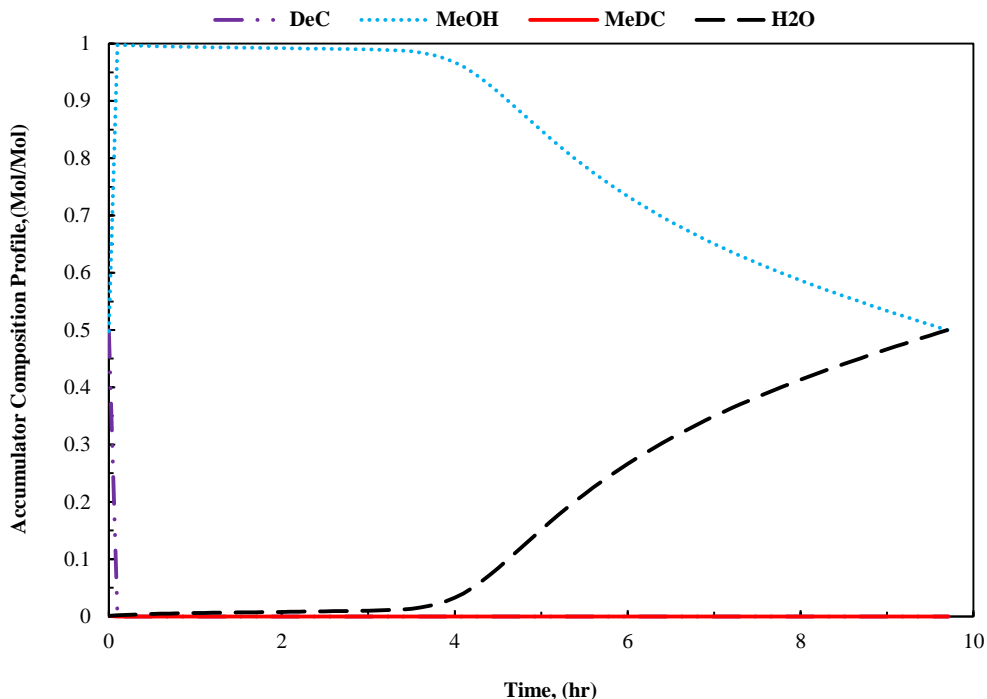

Figure 5: Accumulator composition profiles of DWBD column ($x_{\text{MeDC}}^* = 0.572$).

4.3. The performance of sr-DWBD operation

For the first time, a split reflux divided-wall batch distillation column (sr-DWBD) with refluxing stream of liquid to the still tank (Figure 2c) is presented in this study for the synthesis of MeDC. The main purpose of using sr-DWBD system again in this study is to compare the performance by sr-DWBD column with the DWBD operation (presented in Section 4.2) to see whether can improve the product purity and the overall conversion of acid, where the maximum concentration of MeDC is set to 0.750 mole fraction. Note, the sr-DWBD configurations are kept same as those in the DWBD column for fair comparison (see Section 4.2). Under the presented sr-DWBD mode, the intermediate stages from plate 3 to 8 are shared into two-main sections by a vertical wall. The purity of MeDC consideration is varied from 0.685 to 0.750 in each case study, whereas, the amount of product in the still pot remains the same as 2.5 kmol. For four product purities considered, the optimization results (optimal reflux rate stream, optimal reflux ratio, liquid and vapour split ratios, minimum operating time, total energy expense rate, and the conversion of DeC, as well as total amount of reflux rate over the operating time are listed in Table 5. It can be indicated from Table 5 that the optimal reflux ratio, and the batch time with minimum energy demand and the

maximum conversion level of DeC, as well as total amount of reflux side stream, increase gradually with increasing the product purities.

It is obvious also from Table 5 that higher amount of split stream and higher processing-batch time with higher energy consuming are demanded at 0.750 of MeDC purity as compared to the others to achieve the product requirement (though the reflux rate stream reduces for this case). A comparison of the results between the DeC conversion rate using sr-DWBD system and the DWBD operation conversion (Table 3) illustrates that for the same bottom product amount (2.5 kmol) the sr-DWBD column produced a higher quality of MeDC (0.750 as compared to 0.605), and converted more DeC (80.26% as opposed to only 64.50%).

The mole fractions of the still pot, condenser drum, and the distillate tank of the sr-DWBD scheme at the product purity condition ($x_{\text{MeDC}}^* = 0.750$) are given in Figures 6, 7 and 8, respectively. However, no results were accomplished at a product purity of 0.775 mole fraction as shown in Figure 6 because more amount of water produced by the reaction in the condenser drum and accumulator tank (Figures 7 and 8), which is refluxed back into reboiler drum making the backward reaction is probable. Note, the remixing degree of H₂O with MeOH in the sr-DWBD operation column was reduced and thus improve the process efficiency (Figure 8).

Table 5. Optimal Operation results for the MeDC production for sr-DWBD column at equimolar ratio using one control interval.

Product Purity, x_{MeDC}^*	Optimal Reflux Rate, S, kmol/hr	Optimal Reflux Ratio, R	Liquid, Vapour Split Ratios r_L, r_V	Final Batch time, t_p , hr	Total Energy Usage, Q_{tot} , GJ	Maximum Conversion of DeC (%)	Total Refluxed Amount, kmol
0.685	2.01	0.938	0.52, 26.68	14.91	1.488	73.72	29.94
0.700	1.99	0.952	0.62, 10.86	19.21	1.917	75.13	38.30
0.725	2.05	0.973	4.90, 189.24	33.67	3.383	77.84	69.03
0.750	2.04	0.989	0.51, 38.29	81.66	8.246	80.26	166.58
0.775	--- ^a	--- ^a	--- ^a	--- ^a	--- ^a	--- ^a	--- ^a

^aNot Achievable

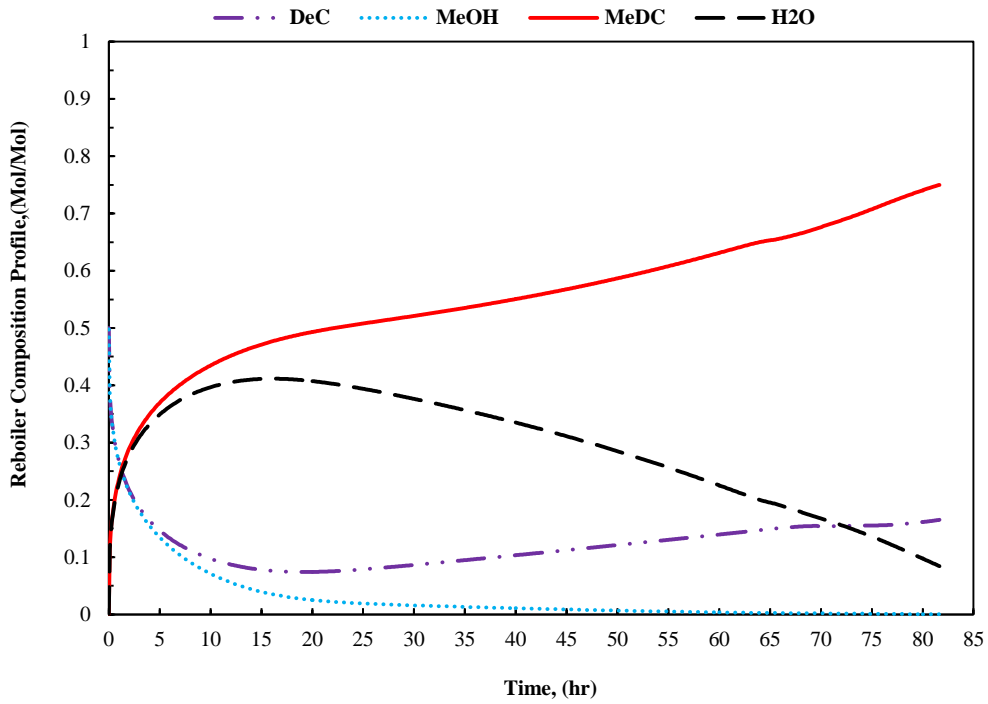

Figure 6: Evolution of the reboiler composition of sr-DWBD column ($x_{MeDC}^* = 0.750$).

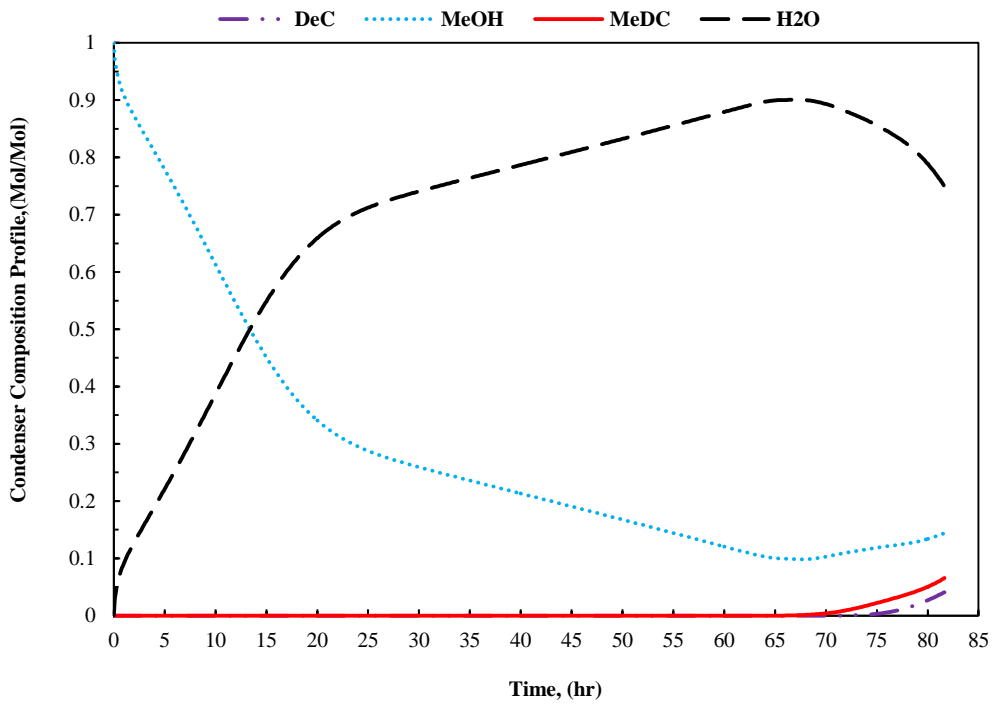

Figure 7: Evolution of the condenser composition of sr-DWBD column ($x_{MeDC}^* = 0.750$).

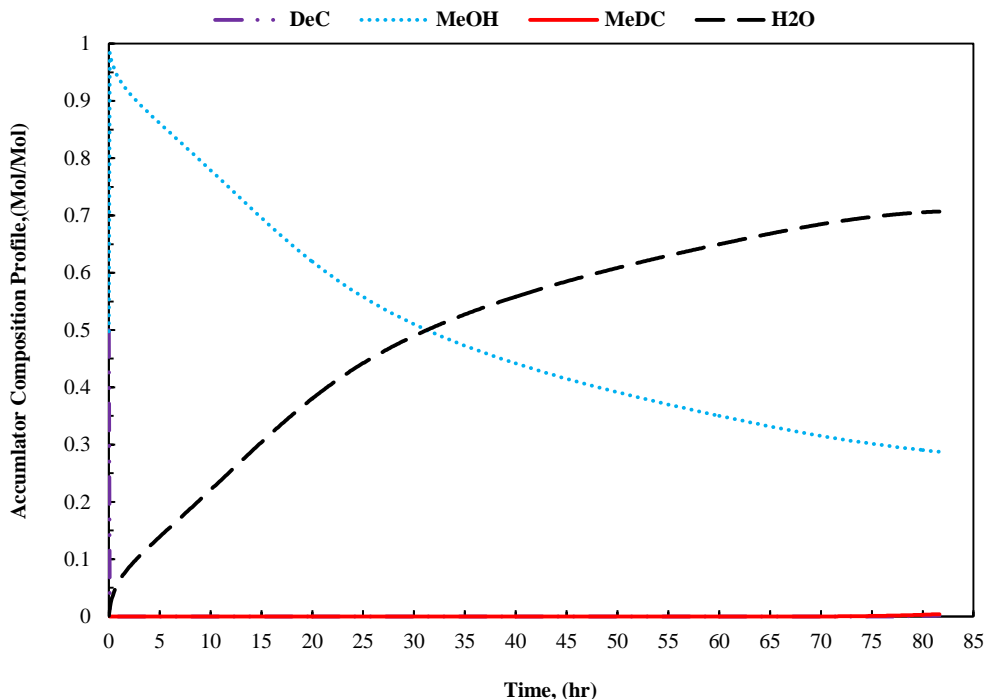

Figure 8: Evolution of the accumulator composition of sr-DWBD column ($x_{\text{MeDC}}^* = 0.750$).

4.4. The performance of i-DWBD operation for the synthesis of MeDC

The operational applicability and economic feasibility of the novel i-DWBD configuration, where a part of the distillate is recycled to the reboiler drum (Figure 2d) as a promising candidate for the MeDC production is proposed here. Under the proposed i-DWBD column, the internal plates from tray 3-8 are vertically portioned into two-closed sections by a metal wall. The tray configurations in both parts of the wall are discussed earlier in section (4.2). Here, the i-DWBD operation is suggested to improve the process efficiency, the energy saving and the economic performance, as well as the maximum achievable conversion. Note, the problem specifications and operating variables for the i-DWBD system are the same as those used in CBD column (see Section 4.1). Two case studies are considered here, Case 1 uses one reflux interval ($\text{NCI} = 1$), whereas, Case 2 uses two reflux intervals strategy ($\text{NCI} = 2$). As stated earlier, the MeDC product concentration is changed from 0.945 to 0.960 mole fraction in each case whilst the reboiler product amount remains the same at 2.5 kmol so that the performance comparison of i-DWBD process can be made with sr-DWBD process in terms of maximum purity of MeDC and higher conversion of DeC into MeDC.

4.4.1 Case 1: Optimal operation employing one control interval

Table 6 displays the optimal methanol recycle rate and reflux ratio profiles, optimal liquid and vapour split ratios, minimum final production time, total energy usage, and the maximum conversion (%) of DeC, as well as methanol recycle amount for different bottom product qualities of MeDC. It can be seen from these results that, as the purity of MeDC rises from 0.945 to 0.960 mole fraction, the reflux ratio, production batch time, and energy consumption rate increase together with the maximum conversion of DeC (%).

Note, there is a sharp increase in production batch time and thus energy consumption as well as the total amount of methanol recycled (Table 6) to increase the purity of MeDC from 0.955 to 0.960 (mole fraction). The distillation column needs to operate at higher reflux ratio and higher recycle rate of methanol to conquer the travel of MeDC up to the distillate receiver, and thus requires a longer batch time to meet the product consideration. As expected, an increase in the production batch time can significantly lead to increase the maximum conversion of DeC into MeDC. A comparison of the results between the conversion of MeDC using i-DWBD column and the sr-DWBD process conversion indicates that for the same amount of bottom product (2.5 kmol) i-DWBD process can synthesis more methyl decanoate at a much higher purity (0.960 compared to 0.750), can convert more decanoic acid (99.95% as opposed to only 80.26%).

Also, the results in Table 6 visibly shows that the proposed i-DWBD column overwhelmingly superior to the sr-DWBD process (Table 5) in terms of higher conversion rate, and purity of the MeDC achieved. This is due to the higher concentration of methanol being recycled back into still pot to have further reaction in the i-DWBD mode (having a significant impact on the MeDC separation) as shown in Figures 10 and 11 as compared to that in the sr-DWBD column (Figures 6 and 8).

Table 6. Optimal Operation results for the MeDC production for i-DWBD column at equimolar ratio using one control interval.

Product Purity, x_{MeDC}^*	Optimal MeOH Recycle S_{MeOH} kmol/hr	Optimal Reflux Ratio, R	Liquid, Vapour Split Ratios r_L, r_V	Final Batch time, t_P , hr	Total Energy Usage, Q_{tot} , GJ	Maximum Conversion of DeC (%)	MeOH Recycled Amount, kmol
0.945	1.22	0.342	3.51, 3.98	5.40	0.509	99.28	6.59
0.950	1.15	0.380	9.96, 8.34	5.69	0.535	99.52	6.52
0.955	1.05	0.440	62.28, 161.45	6.52	0.612	99.79	6.83
0.960	1.21	0.506	5.03, 48.99	80.04	7.197	99.95	96.63

4.4.2 Case 2: Optimal operation employing two control intervals

For different bottom purities considered, the optimization results (including optimal recycle rate of methanol, optimal reflux ratio profiles, optimal liquid and vapour split ratios, optimal switching period, operating batch time, minimum energy usage, and maximum conversion of DeC using two-reflux intervals strategy) are provided in Table 7.

Compared with single-control i-DWBD system (Case 1), the batch-processing time is decreased by about 75.86%, and the total energy demand is cut down by 75.37% for MeDC concentration of 0.960. Although, the DeC conversion rate was found to be the same as that obtained in (Case 1). It is found from Table 7 that the multi-interval policy resulted great savings in batch time and energy consumption rate as compared to the single-interval i-DWBD operation.

This clearly shows the benefit of using multi-intervals operation in i-DWBD column. This advantage is presented in better way in Figure 9 in terms of minimum energy expense at different range of MeDC concentration for both single and two-reflex i-DWBD strategies. It can be noted from Table 7 that at the lower MeDC quality requirement, the batch column runs at lower reflux ratio in the first interval and then at higher reflux ratio in the second interval. While, the distillation column operates with a high reflux ratio in the first interval and then operating at a lower reflux ratio in the second-time interval. More methanol is separated from the column at high concentration in the first interval but is not recycled leading to higher DeC mole fraction in the pot tank and possibly having reverse reaction. Whilst, in the second interval methanol is recycled back into reboiler drum converting most of the DeC and producing MeDC. The mixture composition profiles in the still pot and the collector tank at the product purity constraint ($x_{\text{MeDC}}^* = 0.960$) are depicted in Figures 10 and 11 for the single-reflux interval policy and in Figures 12 and 13 for the multi-reflux intervals policy. It is interesting to note from Figures 10 and 12 that the mole fraction of water (as the second light component) rises from zero reaches to the maximum value, and then progressively falls to almost zero (due to removal in the distillate drum, Figures 11, and 13). As demonstrated in Figures 10 and 12, the concentration of methanol is decreased quickly with increasing the batch time because of its lowest boiling point component and the efficient separation of water, which accumulated eventually in the distillate tank (see Figures 11 and 13). DeC reactant as the heaviest boiling component is nearly consumed due to consumption by reaction with methanol, yielding maximum DeC conversion level at the end of batch operation (see Figures 10 and 12, Table 7). The mole fractions of both reaction reactants

(DeC and MeOH) gradually reduces in the bottom tank as long as the chemical reaction proceeds. As a consequence, more MeDC begins moving up and lastly, the pot drum gets gradually richer with the desired product (methyl decanoate). Moreover, the MeDC in the pot tank reached the maximum achievable purity of 0.960 quicker for the two-reflux operation cases than the single-reflux operation one cases. It can be noticed from Figure 11 that the remixing phenomenon was removed successfully in the i-DWBD. A higher concentration of MeOH is achieved the top of the i-DWBD, and higher purity of MeDC is obtained on the reboiler drum. The purity improvements accomplished by the i-DWBD mode also reflects the reduction of this remixing effect.

Table 7. Optimal Operation results for the MeDC production for i-DWBD column at equimolar ratio using two control intervals.

Product Purity, x_{MeDC}^*	Recycle Rates for intervals S_1, S_2	Reflux Ratios for intervals R_1, R_2	Liquid Split Ratios for intervals r_{L1}, r_{L2}	Vapour Split Ratios for intervals r_{V1}, r_{V2}	Switching Time Intervals t_1, t_2 , hr	Batch time, t_p , hr	Energy Usage, Q_{tot} , GJ	Conversion of DeC (%)
0.955	0.00, 1.29	0.219, 0.416	6.45, 3.98	2.70, 1.68	1.02, 1.82	2.84	0.294	99.28
0.965	0.00, 1.36	0.286, 0.358	15.24, 8.61	1.14, 48.61	1.02, 1.99	3.01	0.307	99.57
0.975	0.00, 1.28	0.248, 0.412	10.51, 7.19	5.40, 176.90	1.02, 2.01	3.03	0.311	99.81
0.985	0.88, 1.51	0.649, 0.345	8.85, 7.96	21.33, 236.7	1.80, 17.53	19.33	1.772	99.86

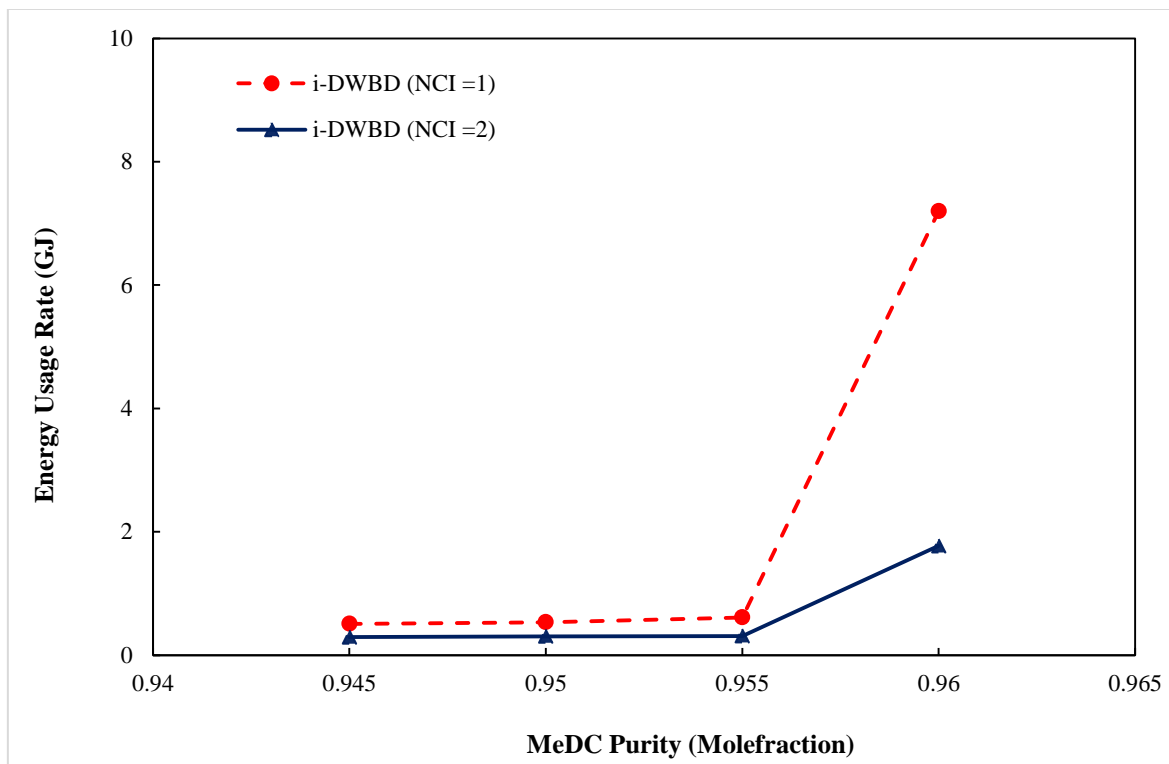

Figure 9: Optimal energy consumption profile for one and multi-reflux i-DWBD operation.

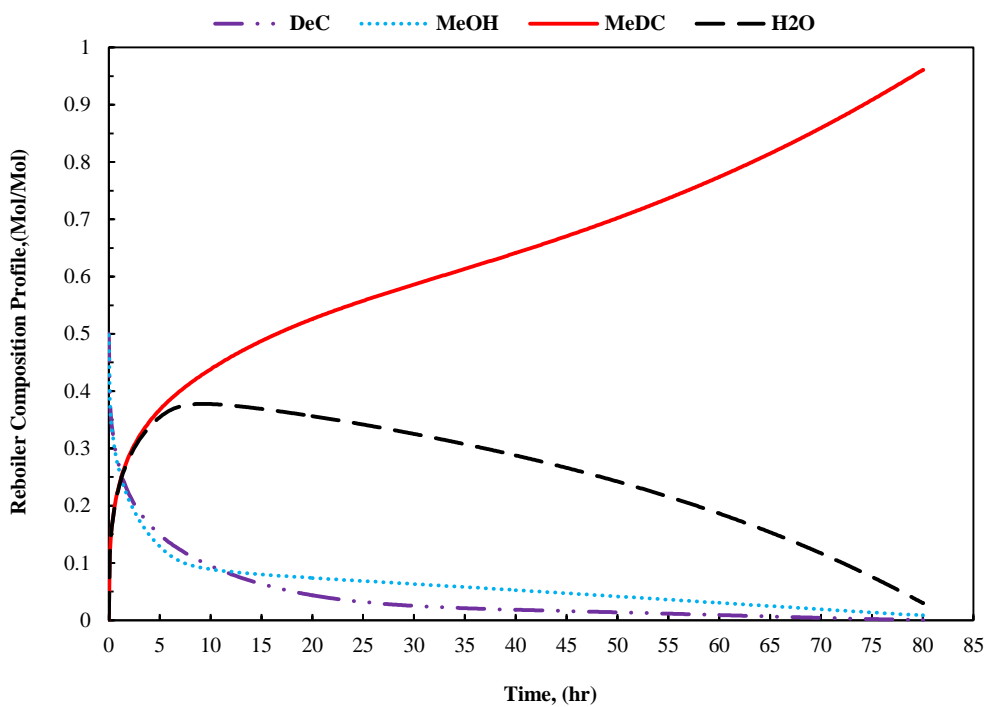

Figure 10: Reboiler composition of i-DWBD column for single-control interval strategy ($x_{\text{MeDC}}^* = 0.960$).

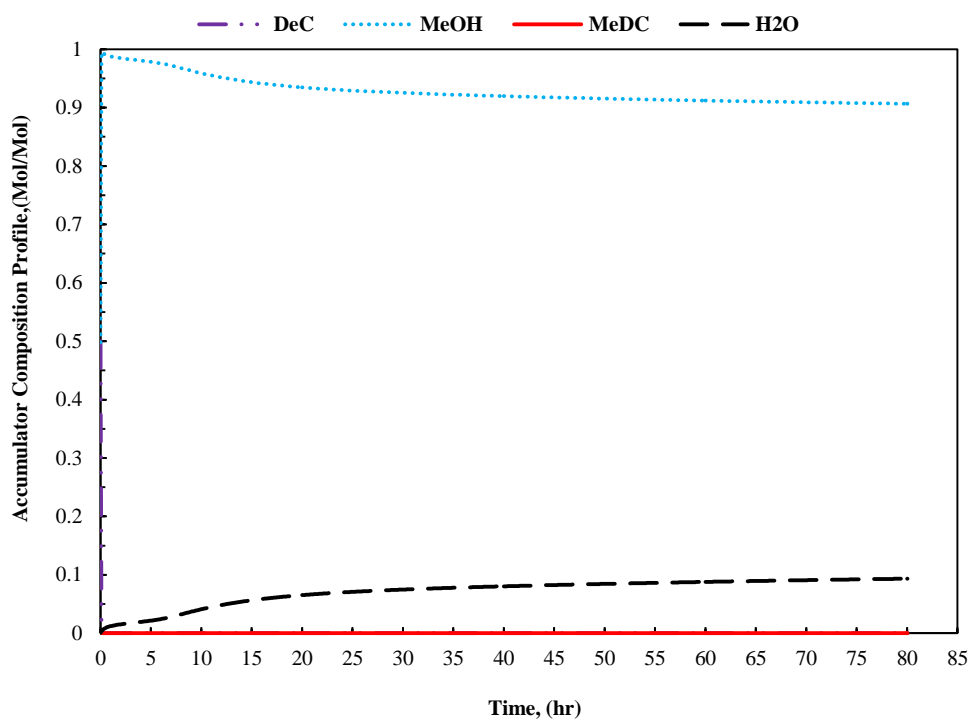

Figure 11: Accumulator composition of i-DWBD column for single-control interval strategy ($x_{\text{MeDC}}^* = 0.960$).

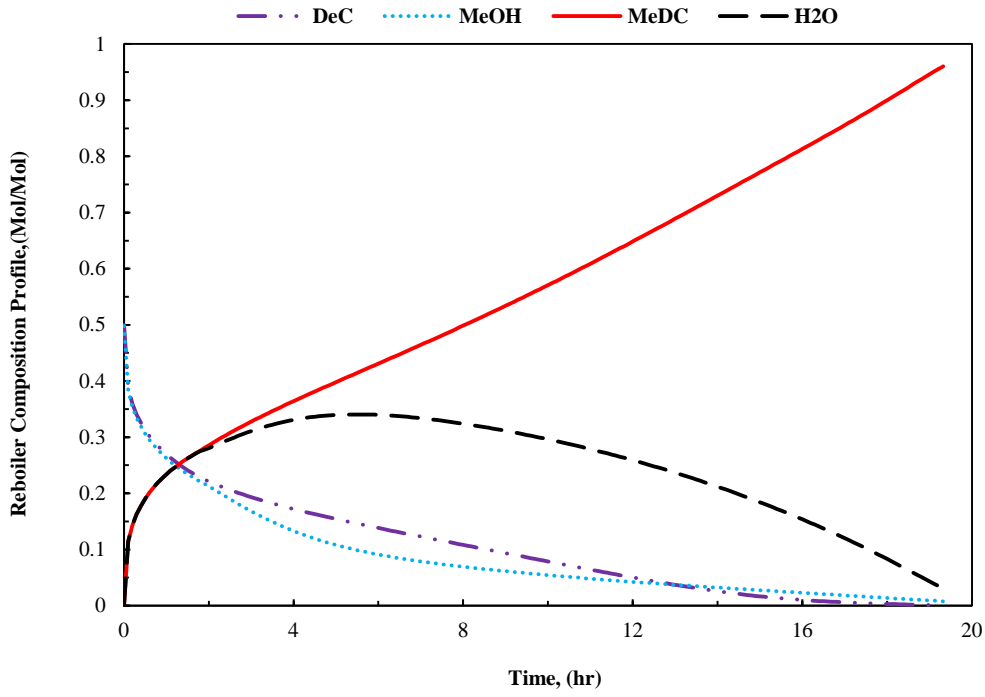

Figure 12: Reboiler composition of i-DWBD column for multi-control interval strategy ($x_{\text{MeDC}}^* = 0.960$).

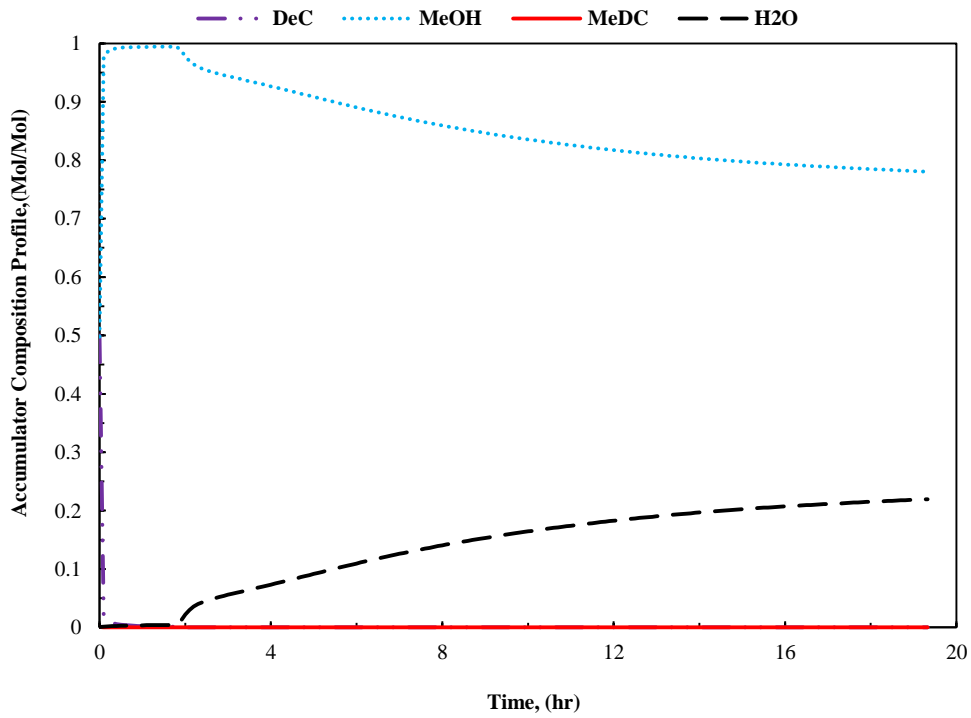

Figure 13: Accumulator composition of i-DWBD column for multi-control interval strategy ($x_{\text{MeDC}}^* = 0.960$).

4.5 The performance of sr-DWBD and i-DWBD columns for MeDC Synthesis with Excess MeOH in the Feed

The influence of excess alcohol (methanol) in the feed mixture on the overall performance of sr-DWBD and i-DWBD operations to achieve maximum possible conversion level and product quality is investigated in detail in this work. Two case studies are examined here. An amount of 5 kmol is loaded initially into the pot tank at the start of the operation with the following concentrations in mole fraction: <0.45 DeC, 0.55 MeOH, 0.0 MeDC and 0.0 H₂O> and the amount of product in the reboiler drum is kept constant at 2.5 kmol (same as used in Sections 4.3 and 4.4) for making useful comparison. As MeOH is the lightest component in the mixture (described earlier), we have used excess alcohol in the initial charge.

4.5.1 Case 1: sr-DWBD column (Excess Methanol)

The optimum results for the sr-DWBD operation are listed in Table 8, including the optimum reflux rate stream, optimum reflux ratio, liquid and vapour split ratios, total operating time, minimum energy usage rate, and the conversion level of DeC, as well as total amount of reflux rate over the batch time for three product purities of MeDC. It can be realized from these results that the optimal reflux ratio, and the batch time with minimum energy consumption and the maximum conversion of acid, as well as total quantity of reflux stream, rise progressively with increasing the MeDC product qualities.

The results in Table 5 clearly present that the sr-DWBD process with the equimolar amount in the feed outperforms the sr-DWBD column with the excess methanol in terms of batch processing time and total energy usage savings to achieve higher MeDC purity considerations except for the conversion ratio of DeC (only an improvement by the sr-DWBD column with the excess methanol). For example, the operating time and the total energy usage employing the sr-DWBD operation with the equimolar amount (in the case of product concentration 0.725 mole fraction) are saved by an average 49.66% compared to that obtained by the sr-DWBD operation with the excess methanol in the feed (Table 8). However, the sr-DWBD system with the excess methanol provided only a better performance than the sr-DWBD column with the equimolar amount in terms of maximum achievable conversion of DeC. For the same amount of reboiler product (2.5 kmol), it converted more decanoic acid (85.09% as opposed to only 80.26%).

Table 8. Optimal Operation results for the MeDC production for sr-DWBD column at excess methanol in the feed.

Product	Optimal	Optimal	Liquid,	Final	Total	Maximum	Total
---------	---------	---------	---------	-------	-------	---------	-------

Purity of x_{MeDC}^*	Reflux Rate, S, kmol/hr	Reflux Ratio, R	Vapour Split Ratios r_L, r_V	Batch time, t_p , hr	Energy Usage, Q_{tot} , GJ	Conversion of DeC (%)	Refluxed Amount, kmol
0.700	1.85	0.961	94.20, 536.96	23.64	2.292	82.30	43.83
0.715	1.84	0.977	4.17, 92.27	39.62	3.856	83.89	73.04
0.725	1.92	0.987	101, 670.00	68.80	6.722	85.09	131.81
0.750	--- ^a	--- ^a	--- ^a	--- ^a	--- ^a	--- ^a	--- ^a

^aNot Achievable

4.5.2 Case 2: i-DWBD column (Excess Methanol)

Table 9 summarizes the results in terms of minimum energy demand, including the optimal methanol recycle rate and reflux ratio profiles, optimal liquid and vapour split ratios, minimum final production time, total energy usage, and the maximum conversion (%) of DeC, as well as methanol recycle amount for different bottom product qualities of MeDC. It can be seen from these results that no results were obtained at a product purity of 0.875 mole fraction due to the consumption of DeC reactant by reaction with methanol. The i-DWBD process with the equimolar amount in the feed is found to offer much better operating flexibility, and maximum conversion rate of acid, as well as much highest product purity compared to the i-DWBD process with the excess amount in the feed (Table 6).

Clearly, the i-DWBD column at the equimolar amount yielded a higher purity of MeDC (0.960 mole fraction), converted more acid (99.95%) compared to those obtained by using excess methanol (Table 9). This obviously establishes that, with different types of divided-wall batch configurations, the employ of excess methanol is not necessary to improve the process efficiency and the product quality. For MeDC quality of 0.860, there is a sharp increase in reflux ratio and operating time resulting in higher total energy consumption rate and total amount of methanol recycled (however the recycle rate of methanol reduced in this case).

It can be noted from both Tables 8 and 9 that the use of excess methanol in the feed mixture can only improve the conversion level of acid, which reduces the desired bottom product purity significantly.

Table 9. Optimal Operation results for the MeDC production for i-DWBD column at excess methanol in the feed.

Product Purity, x_{MeDC}^*	Optimal MeOH Recycle S_{MeOH} , kmol/hr	Optimal Reflux Ratio, R	Liquid, Vapour Split Ratios r_L, r_V	Final Batch time, t_p , hr	Total Energy Usage, Q_{tot} , GJ	Maximum Conversion of DeC (%)	MeOH Recycled Amount, kmol
------------------------------	---	-------------------------	--	------------------------------	------------------------------------	-------------------------------	----------------------------

0.845	1.73	0.171	1.30, 2.53	6.72	0.629	98.21	11.64
0.855	1.71	0.217	5.98, 20.58	9.39	0.869	99.14	16.08
0.860	1.60	0.336	30.95, 25.90	39.52	3.563	99.54	63.31
0.875	--- ^a	--- ^a	--- ^a	--- ^a	--- ^a	--- ^a	--- ^a

^aNot Achievable

5. Conclusions

In this work, the production of methyl decanoate via the esterification reaction of DeC is considered. Due to large gap in boiling points between the reactants, the efficacy of using traditional conventional and dividing-wall batch reactive distillation processes are quite restricted in terms of product purity and reaction conversion because of separation of methanol from DeC in the reactive zone. With the depletion of methanol (one of forward reaction reactant), the backward reaction is being activated along the process decreasing the conversion rate of limiting reactant DeC considerably. In order to overcome these restrictions and to improve the conversion level of DeC into MeDC, an innovative integrated dividing-wall (i-DWBD) is proposed/used here. The performances of those column configurations are evaluated in terms of minimum energy expense under single and two control interval strategies. A detailed model for the process is constructed employing gPROMS Model Builder 5.0 and is incorporated into the optimization problem formulation. A series of minimum energy consumption optimization problem is solved for differing values of MeDC mole fraction ranging from 0.945 to 0.960 mole fraction. The influence of piecewise constants reflux ratio, methanol recycle rate, and the liquid split and vapour split fractions (for i-DWBD column) on the thermal energy consumption are evaluated.

The results demonstrate that the integrated divided-wall batch distillation operation (i-DWBD) is found to outperform all CBD, DWBD and sr-DWBD configurations by achieving the maximum product quality of MeDC and higher conversion rate of DeC. With equimolar feed ratio, the performance of i-DWBD mode was superior to the i-DWBD process with excess feed in terms of product concentration, and conversion of fatty acid. Note also, the optimization results for a defined separation task show that employing of multi-control intervals case is more effective operation compared to the one-control interval case in terms of batch processing time and energy savings in the i-DWBD system. For instance, the batch time and thermal energy minimizations achieved are about 75.86%, and 75.37% at MeDC purity of 0.960 mole fraction compared to that obtained by using one-reflux interval policy. Finally note, the excess methanol in the feed will be required in divided-wall batch reactive operations to only enhance the conversion of the acid.

Nomenclature

a_i	Activity of component i	-
CBD	Convectonal batch distillation	-
CVP	Control vector parameterisation	-
DWBD	Divided-wall batch distillation	-
DAEs	Differential algebraic equations	-
H^L, h^V	Liquid, and vapour enthalpy	kJ/kmol
sr-DWBD	Split reflux divided-wall batch distillation	-
i-DWBD	Integrated divided-wall batch distillation	-
K	Vapour–liquid equilibrium constant	-
L	Liquid flow rate in the column	kmol/hr
L^{PF}	Liquid sent back to the prefractionator	kmol/hr
M_a, M_C	Accumulator and condenser holdup amounts	kmol
M, M_N	stages and reboiler holdup amounts, respectively	kmol
m_{cat}	The catalyst loading	kg
NCI	Number of control intervals	-
NLP	Nonlinear programming problem	-
OP	Optimisation	-
P_{MeDC}	The product amount in the reboiler drum	kmol
Q_C, Q_{heat}	Condenser or reboiler duty	kJ/hr
Q_{tot}	Total Energy Consumption	GJ
r_V	Vapour Split Ratio	-
r_L	Liquid Split Ratio	-
R	Reflux ratio	-
r_A	Reaction rate	mol/g.s

S	Reflux Side Stream to Reboiler	kmol/hr
S_{MeOH}	Recycled Methanol rate	kmol/hr
SQP	Successive quadratic programming algorithm	-
t_1, t_2	Length of interval 1, and 2	hr
t_p	Batch processing time	hr
V_2	Vapour load the condenser	kmol/hr
V^{Pr}	Vapour sent back to the prefractionator	kmol/hr
x	Liquid composition	molefraction
x_a	Accumulated distillate composition	molefraction
x_D	Instant distillate composition	molefraction
y	Vapour composition	molefraction

Greek Letters

Superscripts and subscripts

i	Component number	-
j	tray number	-
Δn	Change in moles due to chemical reaction	-

Abbreviations

DeC	Decanoic Acid
H ₂ O	Water
MeDC	Methyl Decanoate
MeOH	Methanol

6. References

- Aqar, D.Y., Rahmanian, N. and Mujtaba, I.M., (2017). Synthesis of methyl decanoate using different types of batch reactive distillation systems. *Industrial & Engineering Chemistry Research*, 56(14), pp.3969-3982.
- Aqar, D. Y., Rahmanian, N. and Mujtaba, I.M., (2016 a). Methyl Lactate Synthesis using Batch Reactive Distillation: Operational Challenges and Strategy for Enhanced Performance. *Separation and Purification Technology*, 158, 193–203.

- Aqar, D.Y., Rahmanian, N. and Mujtaba, I.M., (2016 b). Integrated Batch Reactive Distillation Column Configurations for Optimal Synthesis of Methyl Lactate. *Chemical Engineering and Processing: Process Intensification*, 108, pp.197-211.
- Asprion, N. and Kaibel, G., (2010). Dividing wall columns: fundamentals and recent advances. *Chemical Engineering and Processing: Process Intensification*, 49(2), pp.139-146.
- Cheng, K., Wang, S.J. and Wong, D.S., (2013). Steady-state design of thermally coupled reactive distillation process for the synthesis of diphenyl carbonate. *Computers & Chemical Engineering*, 52, pp.262-271.
- Dai, X., Ye, Q., Yu, H., Suo, X. and Li, R., (2015). Design and control of dividing-wall column for the synthesis of n-propyl propionate by reactive distillation. *Industrial & Engineering Chemistry Research*, 54(15), pp.3919-3932.
- Dejanović, I., Matijašević, L. and Olujić, Ž., (2010). Dividing wall column - a breakthrough towards sustainable distilling. *Chemical Engineering and Processing: Process Intensification*, 49(6), pp.559-580.
- Delgado-Delgado, R., Hernández, S., Barroso-Muñoz, F.O., Segovia-Hernández, J.G. and Castro-Montoya, A.J., (2012). From simulation studies to experimental tests in a reactive dividing wall distillation column. *Chemical Engineering Research and Design*, 90(7), pp.855-862.
- Ekpo, E.E. and Mujtaba, I.M., (2007). Performance analysis of three controllers for the polymerisation of styrene in a batch reactor. *Chemical Product and Process Modeling*, 2(1), p.1014.
- gPROMS, (2017). *gPROMS Advanced User Guide*. Process Systems Enterprise Ltd., London.
- Harmsen, J., (2010). Process intensification in the petrochemicals industry: drivers and hurdles for commercial implementation. *Chemical Engineering and Processing: Process Intensification*, 49(1), pp.70-73.
- Hernández, S. and Jiménez, A., (1999). Design of energy-efficient Petlyuk systems. *Computers & chemical engineering*, 23(8), pp.1005-1010.
- Hernández, S., Sandoval-Vergara, R., Barroso-Muñoz, F.O., Murrieta-Dueñas, R., Hernández-Escoto, H., Segovia-Hernández, J.G. and Rico-Ramirez, V., (2009). Reactive dividing wall distillation columns: simulation and implementation in a pilot plant. *Chemical Engineering and Processing: Process Intensification*, 48(1), pp.250-258.
- Hernandez, S., Segovia-Hernandez, J.G., Juarez-Trujillo, L., Estrada-Pacheco, J.E. and Maya-Yescas, R., (2010). Design study of the control of a reactive thermally coupled distillation sequence for the esterification of fatty organic acids. *Chemical Engineering Communications*, 198(1), pp.1-18.
- Kaibel, G. (1987). Distillation columns with vertical partitions. *Chemical engineering & technology*, 10(1), pp.92-98.
- Lopez-Saucedo, E.S., Grossmann, I.E., Segovia-Hernandez, J.G. and Hernández, S., (2016). Rigorous modeling, simulation and optimization of a conventional and nonconventional batch reactive distillation column: A comparative study of dynamic optimization approaches. *Chemical Engineering Research and Design*, 111, pp.83-99.
- Machado, G.D., Aranda, D.A., Castier, M., Cabral, V.F. and Cardozo-Filho, L., (2011). Computer simulation of fatty acid esterification in reactive distillation columns. *Industrial & Engineering Chemistry Research*, 50(17), pp.10176-10184.
- Morrison KR., (1984). Optimal control of processes described by systems of differential-algebraic equations. Ph.D Thesis. UK: University of London.

- Mueller, I. and Kenig, E.Y., (2007). Reactive distillation in a dividing wall column: rate-based modeling and simulation. *Industrial & Engineering Chemistry Research*, 46(11), pp.3709-3719.
- Mujtaba, I.M. (2004). *Batch distillation: Design and operation*. London: Imperial College Press.
- Nguyen, N. and Demirel, Y., (2011). Using thermally coupled reactive distillation columns in biodiesel production. *Energy*, 36(8), pp.4838-4847.
- Petlyuk, F.B., Platonov, V.M. and Slavinsk. DM, (1965). Thermodynamically optimal method for separating multicomponent mixtures. *International Chemical Engineering*, 5(3), p.555.
- Safe, M., Khazraee, S.M., Setoodeh, P. and Jahanmiri, A.H., (2013). Model reduction and optimization of a reactive dividing wall batch distillation column inspired by response surface methodology and differential evolution. *Mathematical and Computer Modelling of Dynamical Systems*, 19(1), pp.29-50.
- Steinigeweg, S.; Gmehling, J., (2003). Esterification of a Fatty Acid by Reactive Distillation. *Ind. Eng. Chem. Res.*, 42, 3612.
- Suo, X., Ye, Q., Li, R., Feng, S. and Xia, H., (2017). Investigation about Energy Saving for Synthesis of Isobutyl Acetate in the Reactive Dividing-Wall Column. *Industrial & Engineering Chemistry Research*, 56(19), pp.5607-5617.
- Yildirim, Ö., Kiss, A.A. and Kenig, E.Y., (2011). Dividing wall columns in chemical process industry: a review on current activities. *Separation and Purification Technology*, 80(3), pp.403-417.
- Zheng, L., Cai, W., Zhang, X. and Wang, Y., (2017). Design and control of reactive dividing-wall column for the synthesis of diethyl carbonate. *Chemical Engineering and Processing: Process Intensification*, 111, pp.127-140.