



# The University of Bradford Institutional Repository

<http://bradscholars.brad.ac.uk>

This work is made available online in accordance with publisher policies. Please refer to the repository record for this item and our Policy Document available from the repository home page for further information.

To see the final version of this work please visit the publisher's website. Access to the published online version may require a subscription.

**Link to publisher's version:** <http://dx.doi.org/10.1109/SEGE.2016.7589503>

**Citation:** Okpako O, Rajamani H-S, Pillai P et al (2016) Evaluation of community viral power plant under various pricing schemes. In: 2016 IEEE Conference on Smart Energy Grid Engineering (SEGE),. 21-24 Aug 2016, Canada.

**Copyright statement:** © 2016 IEEE. Personal use of this material is permitted. Permission from IEEE must be obtained for all other uses, in any current or future media, including reprinting/republishing this material for advertising or promotional purposes, creating new collective works, for resale or redistribution to servers or lists, or reuse of any copyrighted component of this work in other works.

# Evaluation of Community Virtual Power Plant under Various Pricing Schemes

Oghenovo Okpako, Haile-Selassie Rajamani, Prashant Pillai, Ugonna Anuebunwa, Faculty of Engineering and Informatics, University of Bradford, UK {ookpako, U.R.Anuebunwa, H.S.Rajamani, P.Pillai @bradford.ac.uk}  
K. Shanti Swarup, Electrical Engineering Department, Indian Institute of Technology, Madras, India swarup@ee.iitm.ac.in

**Abstract**—Technological advancement on the electricity grid has focused on maximizing its use. This has led to the introduction of energy storage. Energy storage could be used to provide both peak and off-peak services to the grid. Recent work on the use of small units of energy storage like battery has proposed the vehicle to grid system. It is proposed in this work to have energy storage device embedded inside the house of the energy consumer. In such a system, consumers with battery energy storage can be aggregated in to a community virtual power plant. In this paper, an optimized energy resource allocation algorithm is presented for a virtual power plant using genetic algorithm. The results show that it is critical to have a pricing scheme that help achieve goals for grid, virtual power plant, and consumers.

**Keywords**—Prosumer; Battery; Virtual Power Plant (VPP); Genetic Algorithm (GA); Smart Grid, State of charge.

## I. INTRODUCTION

The current global challenge of climate change has made it important to use more of renewable energy, and also to minimize the use of energy from non-renewable sources such as fossil fuels. However renewable energy sources are characterized by intermittency, therefore, energy storage is key in maximizing the use of renewable energy. Energy storage can be used to smoothen peak and trough of renewable generation, as well as to provide both peak and off-peak services etc. to the electricity grid. [1], [2], [3].

There is an ongoing global restructuring of electric power utilities [4], [5]. This is changing the electric power utilities from its usual vertically integrated form to a form with a much liberalized market [4], [5], [6]. Therefore, opportunities are created in the electric power market for the energy consumer. With these emerging market opportunities, it is envisaged that the consumer role could change to that of a prosumer which involves both energy consumption and energy production. As the consumer role changes to that of a prosumer, energy storage becomes an important part of the prosumer. With energy storage, a prosumer can buy energy from the grid at a lower cost during off-peak period, and then sell the energy back to the grid at higher prices during peak period. Energy storage could promote the use of renewable energy at the domestic level. This is because peak generation of energy from renewable resources could be stored for future consumption, or sold to the grid at better prices.

Most governments are currently encouraging the use of clean energy from renewable energy sources through the provision of

feed-in tariff, etc. Energy storage could be a way forward to achieve this. In the United Kingdom, government has made energy storage a key strategy in its aim towards reducing greenhouse gas emission by 80% by the year 2050 [7].

The concept of using small unit of energy storage at the domestic side of the electricity grid to participate in the power market was proposed by Kempton [8]. According to Kempton, the battery electric vehicle is not just a load on the utility grid, but an alternative power source. Work on different energy management strategies for dealing with battery electric vehicles has been done by these authors [9] [10] [11]. However, battery electric vehicles are usually mobile and could be limited in their potentials to maximize the use of renewable energy. It is proposed in this work to have energy storage embedded inside the home of the energy consumers.

There are four main power markets in which domestic energy consumer could participate using battery storage. They include baseload power market, peak power market, regulation service power market, and spinning reserve. Base load power market requires the provision of energy round the clock to meet grid's minimum energy demand. Peak power market requires the provision of energy to the grid during peak period. Regulation service power market is a frequency control support service required by the grid. Spinning reserve market requires keeping an extra energy capacity for the grid. This extra capacity can be dispatched within 10 minute when there is grid capacity loss.

Prosumers on their own do not have the negotiating requirements to participate in the power market, as this is done at the wholesale level. Prosumers within a community could be aggregated in to a virtual power plant (VPP). The VPP is a third party agent. Prosumers participation in the power market is done through the VPP. The VPP is an aggregator and a business entity that combine large numbers of small unit of prosumer's energy resource like battery storage, photovoltaics, micro combine heat and power etc. VPP uses the aggregated unit to participate in the power market of the bulk power system on behalf of the prosumer.

The financial incentive for the prosumer is important. This is to encourage the prosumer to remain a participant in the power market. However this incentive should not be achieved at the expense of both the VPP profit and the prosumer's battery life. A proper pricing scheme and coordination of the prosumer's battery energy storage resource are required to achieve a financial reward for both the prosumer and the VPP. For such a system, it is essential to know how to set the electricity prices, particularly the price margin. It is critical to know when and how to utilize the batteries with respect to differential pricing

within the day ahead power market. It is also necessary to control the energy transactions.

This paper proposes the use of genetic algorithms to optimize the energy transactions in a local community, where a virtual power plant is based. The algorithm was tested on an objective function which minimizes the prosumer net cost. The objective function was tested under various pricing scenarios and constraint.

## II. FRAMEWORK OF VIRTUAL POWER PLANT MODEL

Fig. 1, is a diagram describing the VPP model developed in this work.

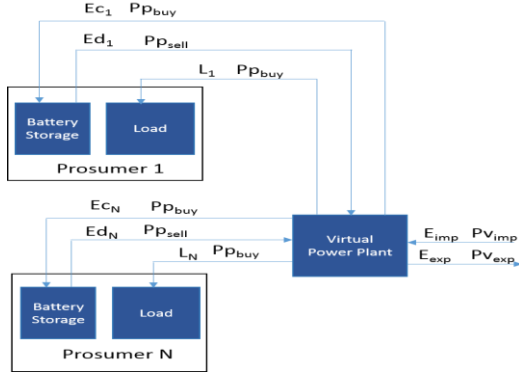

Fig. 1. Architecture of the Virtual Power Plant model.

From Fig 1,  $N$  is the total number of prosumers within the community aggregated as a VPP.  $E_{d1}$  to  $E_{dN}$  is the discharge energy from prosumer 1 to  $N$  battery.  $E_{c1}$  to  $E_{cN}$  is the charge energy for prosumer 1 to  $N$  battery.  $P_{psell}$  is the prosumer sell price of energy from battery, or the price at which the VPP buys energy from the prosumer's battery.  $L_1$  to  $L_N$  is the load demand of prosumer 1 to  $N$ .  $P_{pbuy}$  is the price at which the prosumer buy energy from the VPP to meet its load, or the price at which VPP sells energy to the prosumer to meet load demand.  $E_{imp}$  and  $E_{exp}$  are the amount of energy imported from the grid, and exported to grid by the VPP.  $P_{vimp}$  and  $P_{vexp}$  are the VPP import and export price of energy to the grid.

### A. Virtual power plant

In Fig. 1, the VPP can buy energy in bulk from the grid ( $E_{imp}$ ) at price  $P_{vimp}$  and from the prosumers ( $E_{d1}$  to  $E_{dN}$  from prosumer 1 to prosumer  $N$ ) at price  $P_{psell}$  respectively. The energy bought from the grid is use to meet the prosumer's energy demand ( $L_1$  to  $L_N$ ) as well as to charge their battery. The energy bought from each prosumer's battery ( $E_{d1}$  to  $E_{dN}$  from prosumer 1 to prosumer  $N$ ) are aggregated by the VPP. The aggregated energy is first used within the community to meet each prosumer's load demand respectively before its excess can be traded in the power market (exported to the external grid) by the VPP on behalf of the prosumers.

In this work, the VPP was considered as having a day ahead forecast of each prosumer hourly load profile. Also, the VPP has a day ahead forecast of the price  $P_{vexp}$  at which the external grid would buy its energy (i.e. the day ahead forecast price paid by the grid to the VPP for exporting energy), as well as the day ahead forecast of the price  $P_{vimp}$  at which the grid would sell energy to the prosumer (i.e. the day ahead forecast price paid by VPP to the external grid for importing energy). Both import and export prices for energy are agreed between the VPP and the grid

in the wholesale power market. Based on the day ahead import and export price, the VPP agrees a day ahead prosumer buy and sell price of energy. Thereafter, the VPP has to optimally allocate energy resource by determining its day ahead schedule assuming no error band during forecasting. The day ahead energy resource allocation is done by determining when and which prosumer battery to charge/discharge. Also, the charge/discharge energy from each prosumer battery is determined. Base on the amount of energy to be charge/discharge from the prosumer battery, the amount of energy to be imported from the external grid to meet the prosumer's load demand, as well as the amount of energy to be exported to the external grid is then determine. The VPP can only export energy after the load demand of the prosumers are first met by the energy discharge from the prosumers battery. Ideally, the virtual power plant wants to make profit as a business entity. This was investigated in the pricing schemes.

### B. Prosumer

A community consisting of three prosumers ( $N=3$ ) was considered in this model. Each prosumer was considered as having energy storage embedded inside their home. Each battery is considered as having a state of charge of 50 % respectively. The day ahead hourly load profile of each prosumer is shown in Fig. 2. Fig. 2, is a typical hourly load profile of three different class of domestic energy consumers within residential community in the United State. This data was obtained from Xcel energy [13].

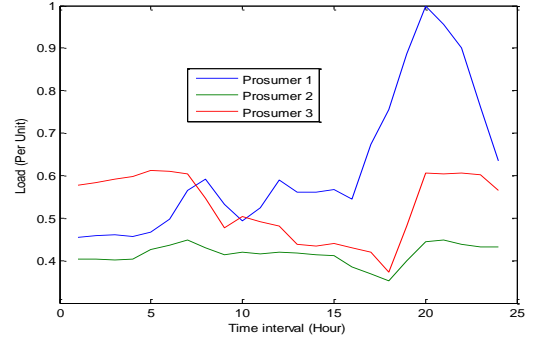

Fig. 2. Forecasted hourly load profile of each prosumer.

Each of the prosumers has a different hourly load profile. The objective of the prosumer as a participant in the VPP, is to minimize its net cost (energy purchasing cost). In this work, a lower net cost represents an incentive received by the prosumer for participating as part of a VPP in its local community.

## III. MATHEMATICAL TOOL USED IN MODELLING

### A. VPP Energy Balance

The VPP energy balance is formulated on the basis of per prosumer. Therefore the VPP energy balance during import and export of energy during the time interval  $t$  is calculated in (1) as follows.

$$E_{g_{i,t}} = L_{i,t} + Ecd_{i,t} \quad (1)$$

$$Ecd_{i,t} = \begin{cases} E_{c_{i,t}}, & \text{if battery charging occur} \\ -E_{d_{i,t}}, & \text{if battery discharging occur} \\ 0, & \text{if battery is idle} \end{cases}$$

$$\begin{cases} \text{if } E_{g_{i,t}} > 0, E_{imp_{i,t}} = E_{g_{i,t}} \\ \text{if } E_{g_{i,t}} < 0, -E_{exp_{i,t}} = E_{g_{i,t}} \\ \text{if } E_{g_{i,t}} = 0, E_{imp_{i,t}} = E_{exp_{i,t}} = 0 \end{cases}$$

Where  $i$  is an integer.  $N$  is the total number of prosumers connected to the VPP.  $t$  is the time interval.  $E_{g_{i,t}}$  is the amount of energy exchange in per unit between the VPP and the grid on behalf of prosumer  $i$  during  $t$ .  $E_{imp_{i,t}}$  and  $E_{exp_{i,t}}$  are the amount of import energy and the amount of export energy in per unit respectively allocated to prosumer  $i$  by the VPP during  $t$ .  $E_{cd_{i,t}}$  is the amount of energy exchange in per unit between prosumer  $i$  battery and the VPP during  $t$ .  $E_{c_{i,t}}$  and  $E_{d_{i,t}}$  are the amount of charge and discharge energy in per unit respectively allocated to prosumer  $i$  battery by the VPP during  $t$ .  $L_{i,t}$  is the load of prosumer  $i$  in per unit during  $t$ . The load is fixed.

### B. VPP Profit

The VPP profit  $Vpp_{profit}$ , at each time interval  $t$  over the day's total number of time interval ( $T$ ) is calculated as follows.

$$\sum_{t=1}^T Vpp_{profit_t} = \sum_{t=1}^T (Vpp_{rev_t} - Vpp_{cost_t}) \quad (2)$$

Where  $Vpp_{rev_t}$  and  $Vpp_{cost_t}$  are the VPP revenue and cost respectively during the time interval  $t$ .  $T$  is the day's total number of time interval. Both VPP revenue and cost are calculated respectively in (3) and (4) as follows.

$$\sum_{t=1}^T Vpp_{rev_t} = \sum_{i=1}^N \sum_{t=1}^T \left( Pp_{buy_t} \cdot (L_{i,t} + E_{c_{i,t}}) + Pv_{exp_t} \cdot E_{exp_{i,t}} \right) \quad (3)$$

$$\sum_{t=1}^T Vpp_{cost_t} = \sum_{i=1}^N \sum_{t=1}^T (Pr_{sell_t} \cdot E_{d_{i,t}} + Pv_{imp_t} \cdot E_{imp_{i,t}}) \quad (4)$$

Where  $Pp_{sell_t}$ ,  $Pp_{buy_t}$ ,  $Pv_{imp_t}$ , and  $Pv_{exp_t}$  are the prosumer selling price of energy to the VPP, prosumer buy price of energy from the VPP, the VPP import price of energy, and the VPP export price of energy respectively during  $t$ . These prices are measured in pence/per unit.

### C. Prosumer Net Cost

The prosumer's net cost  $Pp_{cost}$ , at each time interval  $t$  over the day's total number of time interval  $T$  is calculated as follows.

$$\sum_{t=1}^T Pp_{cost_t} = \sum_{i=1}^N \sum_{t=1}^T \left( Pp_{buy_t} \cdot (L_{i,t} + E_{c_{i,t}}) - Pp_{sell_t} \cdot E_{d_{i,t}} \right) \quad (5)$$

### D. Battery State of Charge.

The battery state of charge (SOC) gives an information on the battery energy level. In this work, the battery energy level is measured in per unit. Usually the battery SOC cannot be measured directly, but can be inferred from the battery energy level. Therefore, the battery state of charge of charge is a measure of the battery energy level in comparison to the battery

actual capacity, assuming an ideal battery with no peukert effect, no losses (self-discharge) and whose actual capacity is the same as its nominal capacity. The state of charge is measured in percentage. It also gives an information on the battery depth of discharge. The battery energy level measured during  $t$  is calculated as follows.

$$E_{stored_{i,t}} = E_{o_i} + \sum_{t=1}^T E_{cd_{i,t}} \quad (6)$$

$E_{stored_{i,t}}$  is prosumer  $i$  battery energy level in per unit measured at.  $E_{o_i}$  is prosumer  $i$  initial battery energy level in per unit before participation in the day ahead power market.  $t$ . The prosumer battery SOC is calculated as follows.

$$SOC_{i,t} = 100 \frac{E_{stored_{i,t}}}{E_{batt_i}} \quad (7)$$

$SOC_{i,t}$  is the state of charge of prosumer  $i$  battery measured in percentage during  $t$ .  $E_{batt_i}$  is the actual battery capacity in per unit of prosumer  $i$ .

### E. Battery Constraints

Each prosumer battery discharge constraint is represented as follows.

$$E_{d,\min_i} \leq E_{d_{i,t}} \leq E_{d,\max_i} \quad (8)$$

Where  $E_{d,\min_i}$  and  $E_{d,\max_i}$  are the minimum and maximum discharge energy that can be allocated to prosumer  $i$  battery. Each prosumer battery charge constraint is represented as follows.

$$E_{c,\min_i} \leq E_{c_{i,t}} \leq E_{c,\max_i} \quad (9)$$

Where  $E_{c,\min_i}$  and  $E_{c,\max_i}$  are the minimum and maximum charge energy that can be allocated to prosumer  $i$  battery. Each prosumer battery state of charge constraint is represented as follows.

$$SOC_{\min_i} \leq SOC_{i,t} \leq SOC_{\max_i} \quad (10)$$

Where  $SOC_{\min_i}$  and  $SOC_{\max_i}$  are the minimum and maximum state of charge of charge limit of prosumer  $i$  battery.

## IV. GENETIC ALGORITHM IMPLEMENTATION

To understand the optimization problem, the number of prosumer chosen to participate in the VPP was kept at three. The optimization function is the prosumer net cost. This is gotten from (5) and is represented as follows.

$$[Min]F = \sum_{t=1}^T Pp_{cost_t} \quad (11)$$

$F$  is the prosumer net cost, and is the objective function to be minimize. In this work, both  $E_{d,\min}$  and  $E_{d,\max}$  values were chosen to be 0 and 1 per unit respectively for each and every prosumers.  $E_{c,\min}$  and  $E_{c,\max}$  where chosen to be 0 and 1 respectively for each

prosumer.  $E_{batt}$  (actual battery capacity) for each prosumer was chosen to be 24 per unit respectively.  $E_o$  (Initial battery energy level) was chosen to be 12 per unit respectively. Genetic Algorithm (GA) was used to determine the optimum day ahead energy charge/discharge pattern from the battery given the day ahead pricing regimes and prosumer's load profile to the VPP. GA is a search and optimization technique that is based on "Darwin" theory of evolution. To implement GA, an initial population of one thousand chromosome was randomly generated considering battery constraints. These chromosome represents the initial candidate solutions to the optimization problem  $F$ . Each chromosome is composed of three genes. Each gene represent the charge/discharge energy variable from each of the three prosumers battery respectively. Each gene is composed of 24 DNA which represents the prosumer's battery charge/discharge energy at each time interval of  $t$  (an hour) over the day's total number of time interval  $T$  (24 hours). Fitness function ( $F$  in equation (11)) was used to calculate the fitness value of each chromosome. Selection, based on fitness value was used to eliminate half of the chromosome population that has the least fitness value. Random crossover points, and random pairs where used to generate a new population. The cycle is then repeated in order to reach an optimum solution.

## V. RESULTS AND DISCUSSION

Fig. 3, shows the proposed pricing scheme used by the VPP. Both import and export price are set based on the energy need of the grid (i.e. peak and off-peak).

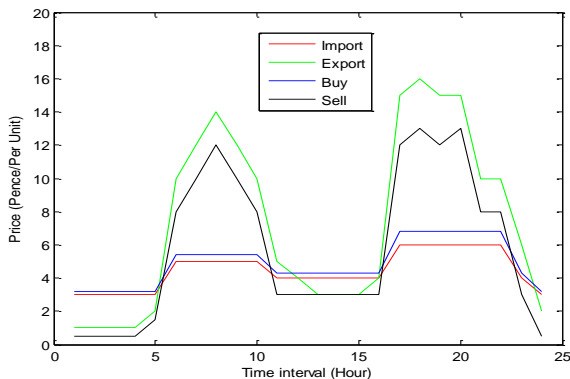

Fig. 3. Proposed pricing scheme.

As it is noticed in Fig.3, during the off-peak period (early hours of the day) the grid is not willing to buy energy from the VPP due to expected low energy demand. It therefore agrees to buy energy (export energy) from the VPP at a price lower than it would sell to the VPP. At that time, it is expected that the VPP should purchase enough energy (import energy) to charge its prosumer battery. During the peak period, the grid is willing to buy energy from the VPP to meet its high energy demand. Therefore it offers to buy energy from the VPP at a price much higher than it would sell to the VPP. Based on the import and export prices of energy, the VPP sets the prosumer buy and sell price of energy. It is noticed in Fig. 3, that during off-peak period, the VPP offers to buy energy from the prosumer at a price lower than it would sell to prosumer. However, during peak period, the VPP offers to buy energy at a price much higher than it would sell to prosumer. This pricing scheme was tested under GA. Fig.4, shows how the prosumer net cost, VPP profit, and prosumer battery energy level changes as the

algorithm optimizes and finally converges. The energy level represents the amount of energy remaining in the prosumer battery after it has participated in the day ahead market.

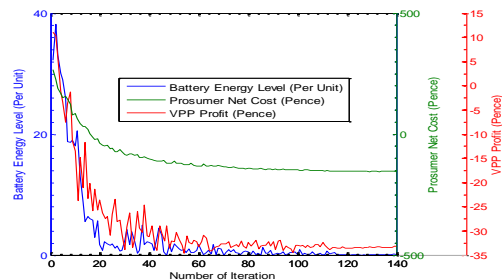

Fig. 4. Effect of optimization on community (using proposed pricing).

As shown in Fig. 4, both the prosumer net cost, VPP profit and the prosumer battery energy level reduces and finally converges during the optimization. While this is good for the prosumer in terms of incentive, it is not good for the VPP whom is in business and needs to make profit to remain in business. This is also not good for the prosumer battery whose energy level reduces to zero. The prosumer net cost reduces at the expense of the VPP profit. The VPP is operating at a loss because the price margin between the prosumer sell price and buy price during peak is higher than the price margin between the prosumer sell price and VPP export price. Fig. 5 and Fig. 6 are the battery charge, and state of charge respectively.

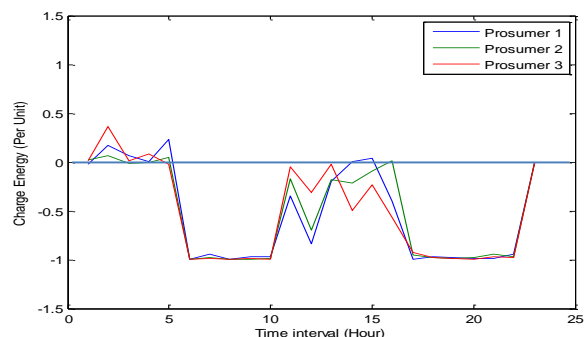

Fig. 5. Battery charge.

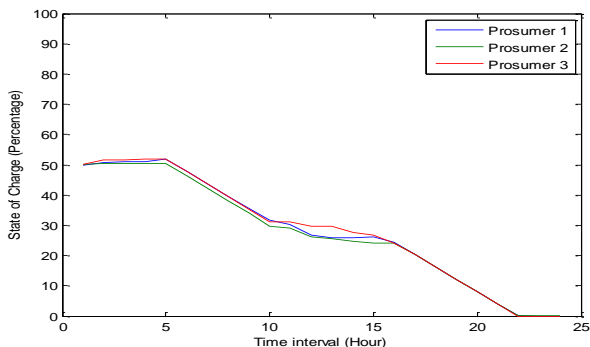

Fig. 6. Battery state of charge.

In Fig. 5, the positive values on the y-axis represents battery charge, while the negative value represents battery discharge. In Fig. 5, the prosumer's batteries are discharging at peak period, which is good for the grid. However, the off peak period

is still not fully utilized for charging the prosumer battery. This may not be good for the grid in terms of energy balancing. Fig. 6, shows that the prosumer battery state of charge reduces to zero percent. Which is as a result of underutilization of the off-peak period for charging of the prosumer battery. The underutilization of the off-peak period, is because of the optimization which was considered for one day. This prevents the battery from charging if it is not guaranteed of discharging. Fig. 7 and Fig. 8, are the VPP energy import and export allocated to each prosumer.

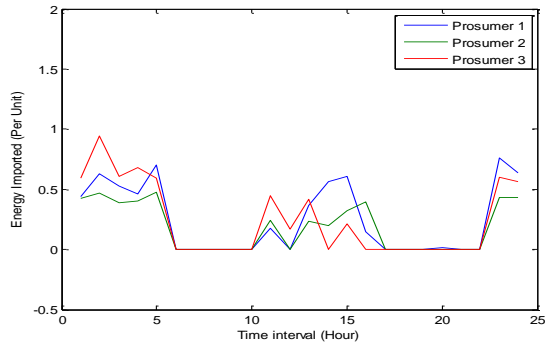

Fig. 7. VPP Energy import allocated to each prosumer.

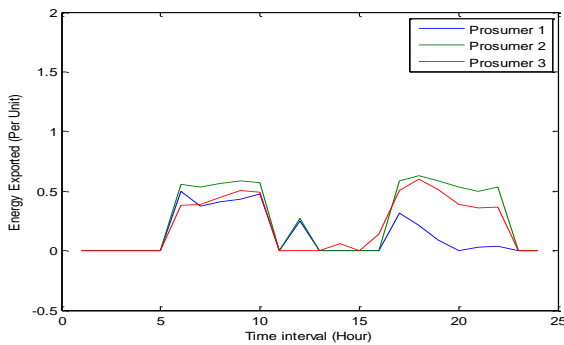

Fig. 8. VPP Energy export allocated to each prosumer.

Fig. 7 and Fig. 8, shows VPP import and export energy respectively. It is observed that energy is imported from the grid at off-peak period. However the energy imported from the grid is mainly used at meeting the prosumer load demand, and not for charging the battery. This is an issue, as prosumers battery are supposed to fully utilize the off peak period for charging. In Fig 8, energy is exported to the grid during peak. This provides good incentive for the prosumer, as well as support for the grid. In order to make sure that the VPP makes profit, the margin between the VPP export and the prosumer sell price is modified (increased compared to Fig. 3). This is shown in Fig. 9.

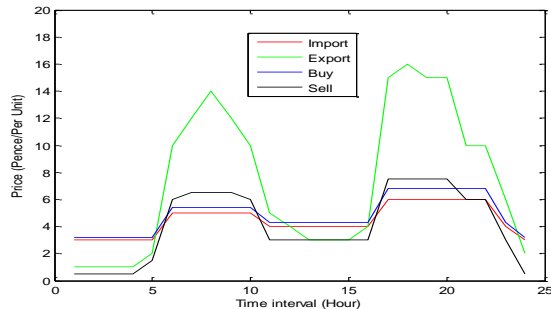

Fig. 9. Modified pricing scheme.

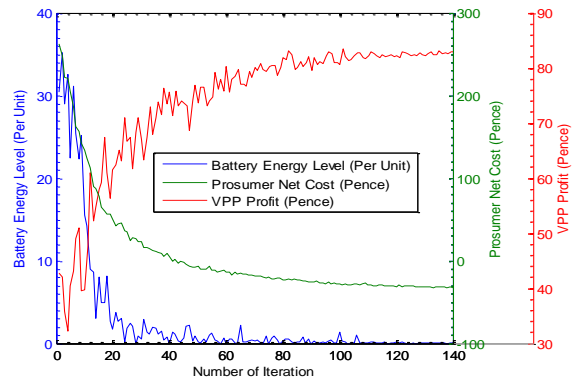

Fig. 10. Effect of optimization on community (using modified pricing).

In Fig. 10, the prosumer net cost decreases as the algorithm optimizes until it converges. Also, the VPP profit increases and finally converges. Though the objective function is minimization of the prosumer net cost, the modified pricing scheme favors both the prosumer and the VPP.

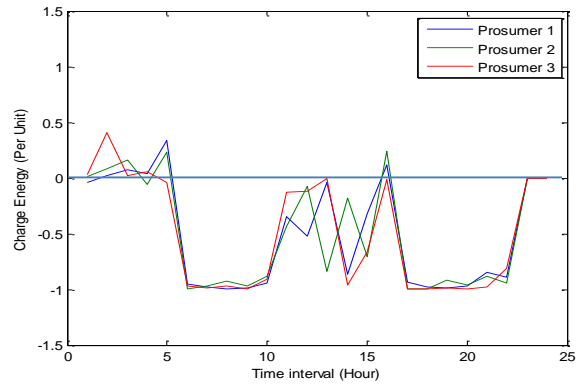

Fig. 11. Battery charge.

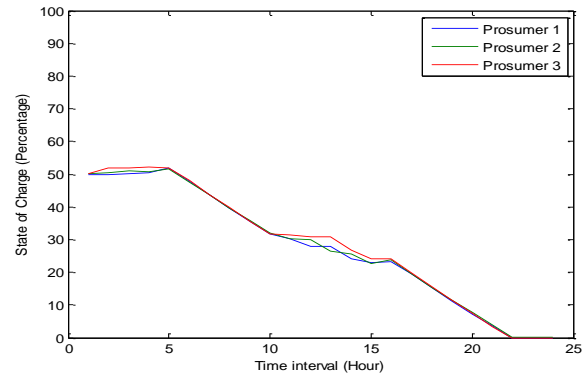

Fig. 12. Battery state of charge.

Though the VPP makes profit, and the prosumer has an incentive. However as observed in Fig. 11, the off-peak period are still not fully utilize for charging of the prosumer battery. In Fig. 12, the battery state of charge at the end of participation in the power market is still at zero percent for all prosumer. Ideally most batteries are not supposed to discharge that low. For example, deep cycle lead acid battery can only cope with a minimum state of charge of around 20% [12]. A low state of charge reduces the life cycle and capacity of most battery. Fig

13, and Fig 14, shows the VPP energy import and export allocated to each prosumer.

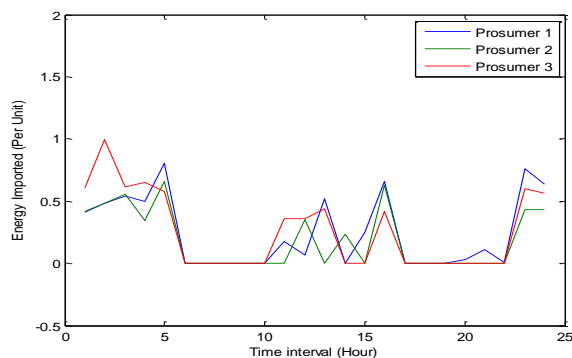

Fig. 13. VPP Energy import allocated to each prosumer.

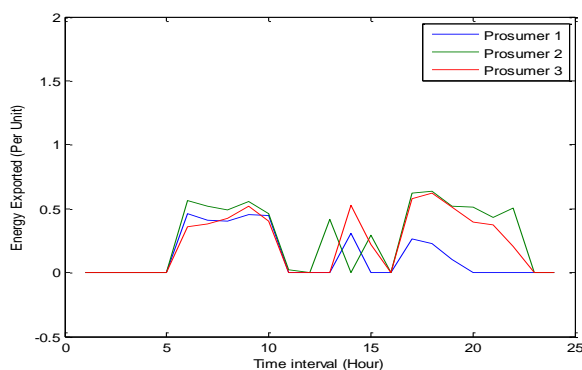

Fig. 14. VPP Energy export allocated to each prosumer.

In Fig 13, energy is imported from the grid during the off-peak period. The imported energy is mainly use at meeting the load demand of the prosumer and not for charging of the battery. In Fig. 14, energy is exported to the grid during the peak hours. This is good for the grid, as it requires support during the peak period. These experiments has shown that VPP require careful pricing scheme. Optimization technique will give results based on pricing scheme. Whilst economic model is to attach a price for the benefit of the grid, prosumer and VPP, it is important to identify the price margin required. Also, battery minimum state of charge still needs to be accounted for. This would be carried out in future work.

## VI. CONCLUSIONS

In this paper, it has been demonstrated that it is possible to have a virtual power plant that involves embedded energy storage at the domestic level. It has been shown that price margin plays a key role. Particularly, the price margin that exist between all the prices (i.e. prosumer buy, prosumer sell, VPP import, and export price). This is because genetic algorithm would make use of the price margin during optimization. Whilst daily optimization may be possible to seek daily optimum, it is essential to also account for battery minimum state of charge. This would allow battery storage to better provide off-peak service to the grid as well as improve its lifetime. This factor should be accounted for in any optimization. In this paper GA algorithm has been used to optimize a local community. It is feasible that adjustment of the loads is possible in scheduling.

## ACKNOWLEDGMENTS

Mr. Oghenovo Okpako is grateful to the Niger Delta Development Commission of Nigeria for funding the work. The work has been also supported by the British Council and the UK Department of Business innovations and Skills under the GII funding of the SITARA project.

## REFERENCES

- [1] H. L. Ferreira, R. Garde, G. Fulli, W. Kling, and J. P. Lopes, "Characterisation of electrical energy storage technologies," *Energy*, vol. 53, no. pp. 288-298, 2013.
- [2] V. A. Boicea, "Energy Storage Technologies: The Past and the Present," *Proceedings of the IEEE*, vol. 102, no. 11, pp. 1777-1794, 2014.
- [3] IEA, "Technology roadmap: energy storage," Paris 2014.
- [4] X. Vallvé, A. Graillot, S. Gual, and H. Colin, "Micro storage and demand side management in distributed PV grid-connected installations," in *Electrical Power Quality and Utilisation, 2007. EPQU 2007. 9th International Conference on*, 2007, pp. 1-6.
- [5] A. Ihabal, H. Rajamani, R. Abd-Alhameed, M. Jalboub, A. Elmeshregi, and M. Aljaddal, "Development of Electricity Pricing Criteria at Residential Community Level," *Universal Journal of Electrical and Electronic Engineering*, vol. 2, no. 2, pp. 81-89, 2014.
- [6] E. Veldman, M. Gibescu, J. Sloopweg, and W. Kling, "Technical benefits of distributed storage and load management in distribution grids," in *PowerTech, 2009 IEEE Bucharest*, 2009, pp. 1-8.
- [7] G. Strbac, M. Aunedi, D. Pudjianto, P. Djapic, F. Teng, A. Sturt, D. Jackravut, R. Sansom, V. Yufit, and N. Brandon, "Strategic assessment of the role and value of energy storage systems in the UK low carbon energy future," *Report for Carbon Trust*, no., 2012.
- [8] W. Kempton and S. E. Letendre, "Electric vehicles as a new power source for electric utilities," *Transportation Research Part D: Transport and Environment*, vol. 2, no. 3, pp. 157-175, 1997.
- [9] D. Wu, D. C. Aliprantis, and L. Ying, "Load scheduling and dispatch for aggregators of plug-in electric vehicles," *Smart Grid, IEEE Transactions on*, vol. 3, no. 1, pp. 368-376, 2012.
- [10] C. Pang, V. Aravinthan, and X. Wang, "Electric vehicles as configurable distributed energy storage in the smart grid," in *Power Systems Conference (PSC), 2014 Clemson University*, 2014, pp. 1-5.
- [11] A. Brooks, E. Lu, D. Reicher, C. Spirakis, and B. Weihl, "Demand dispatch," *Power and Energy Magazine, IEEE*, vol. 8, no. 3, pp. 20-29, 2010.
- [12] K. C. Divya and J. Østergaard, "Battery energy storage technology for power systems—An overview," *Electric Power Systems Research*, vol. 79, no. 4, pp. 511-520, 2009.
- [13] Xcel Energy, "Hourly Load Profile" 2012. [https://www.xcelenergy.com/staticfiles/xcel/Corporate/Corporate%20PDFs/AppendixD-Hourly\\_Load\\_Profiles.pdf](https://www.xcelenergy.com/staticfiles/xcel/Corporate/Corporate%20PDFs/AppendixD-Hourly_Load_Profiles.pdf)